

Ethernet Core Modules with High-Performance Connectivity Options

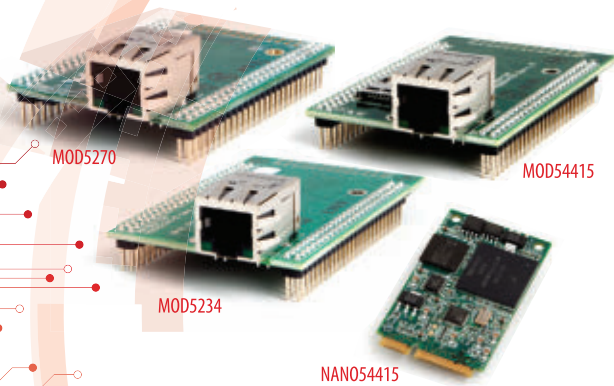

- **MOD5270**
147.5 MHz processor with 512KB Flash & 8MB RAM · 47 GPIO · 3 UARTs · I²C · SPI
- **MOD5234**
147.5 MHz processor with 2MB flash & 8MB RAM · 49 GPIO · 3 UARTs · I²C · SPI · CAN · eTPU (for I/O handling, serial communications, motor/timing/engine control applications)
- **MOD54415**
250 MHz processor with 32MB flash & 64MB RAM · 44 GPIO · 8 UARTs · 5 I²C · 3 SPI · 2 CAN · SSI · 8 ADC · 2 DAC · 8 PWM · 1-Wire[®] interface
- **NANO54415**
250 MHz processor with 8MB flash & 64MB RAM · 30 GPIO · 8 UARTs · 4 I²C · 3 SPI · 2 CAN · SSI · 6 ADC · 2 DAC · 8 PWM · 1-Wire[®] interface

Add Ethernet connectivity to an existing product, or use it as your product's core processor

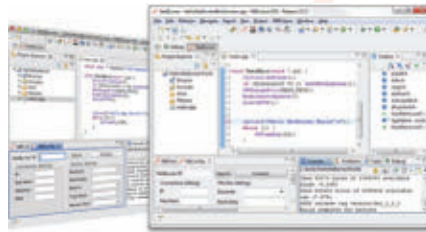

The goal: Control, configure, or monitor a device using Ethernet

The method: Create and deploy applications from your Mac or Windows PC. Get hands-on familiarity with the NetBurner platform by studying, building, and modifying source code examples.

The result: Access device from the Internet or a local area network (LAN)

The NetBurner Ethernet Core Module is a device containing everything needed for design engineers to add network control and to monitor a company's communications assets. For a very low price point, this module solves the problem of network-enabling devices with 10/100 Ethernet, including those requiring digital, analog and serial control.

MOD5270-100IR.....\$69 (qty. 100)	NNDK-MOD5270LC-KIT \$99
MOD5234-100IR.....\$99 (qty. 100)	NNDK-MOD5234LC-KIT\$249
MOD54415-100IR.....\$89 (qty. 100)	NNDK-MOD54415LC-KIT\$129
NANO54415-200IR...\$69 (qty. 100)	NNDK-NANO54415-KIT..... \$99

NetBurner Development Kits are available to customize any aspect of operation including web pages, data filtering, or custom network applications. The kits include all the hardware and software you need to build your embedded application.

➤ **For additional information please visit**
<http://www.netburner.com/kits>

September 2013

28 Build a Headset Amplifier

This project uses all discrete components and can be driven by a CD or MP3 player. Plus, it's a forgiving circuit for beginners.

■ By Ronald Anderson

34 Detecting Sounds With the Sonic Sensor

Put your appliances under sonic control with this super souped-up version of a "clapper."

■ By Thomas Henry

40 Build This Simple Alarm System With the TI Launchpad

Constructing an alarm system complete with a keypad interface is cheap and simple with Texas Instruments' MPSP430 microprocessor and their easy-to-use Flash programmer and debugging tool.

■ By Derek Tombrello

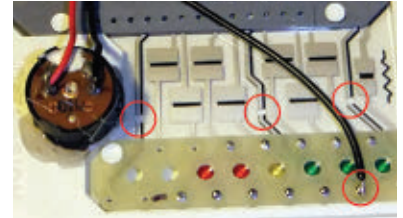

Columns



Page 08

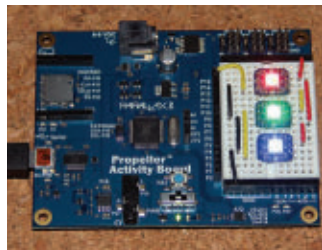

Page 50

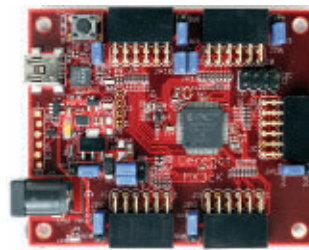

Page 57

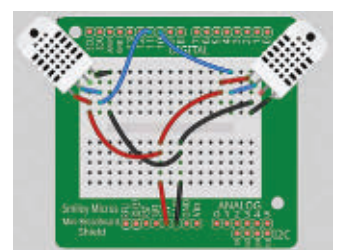

Page 69

08 TechKnowledgey 2013

Events, Advances, and News

Harpooning your brain, free secure browsing, virtual money, and high-end ear buds are some of the titillating topics covered.

12 Near Space

Approaching the Final Frontier

The 2013 Great Plains Super Launch. This year's conference included topics such as near space STEM, designing and flying photometers, long-duration balloon flights and telemetry modes, and vacuum cannons.

16 Q & A

Reader Questions Answered Here

ESD instrument circuits, more about making sparks, VFO design, and MailBag round out this month's topics.

50 The Spin Zone

Adventures in Propeller Programming

Full Color With One Wire.

LED manufacturers are creating some pretty cool products these days, and with just a little bit of programming, you can have a lot of fun with them.

57 The Design Cycle

Advanced Techniques for Design Engineers

Home Automation Telegesis Style.

Absolutely zero ZigBee technical knowledge (or a third mortgage) is needed to put the Telegesis home automation radios to work.

69 Smiley's Workshop

Programming • Hardware • Projects

Arduino Handheld Prototyper — Part 3.

Design a fresh air controller for your castle, or wherever you call home.

Departments

06	DEVELOPING PERSPECTIVES <i>Nostalgia and the Amnesia of Time</i>	64	NV WEBSTORE
07	READER FEEDBACK	67	ELECTRO-NET
22	NEW PRODUCTS	77	CLASSIFIEDS
27	SHOWCASE	78	TECH FORUM
		81	AD INDEX

5V Step-Up Voltage Regulator U1V11F5

ITEM #2562

\$4⁹⁵



Adjustable and 3.3V versions available

- 0.5 V to 5.5 V input
- True shutdown, linear down-regulation
- 70% to 90% efficiency

170-Point Breadboard

ITEM #1491

\$2⁹⁵

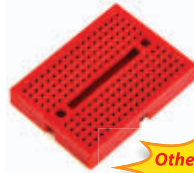

Other colors available

- 17 rows of tie points for up to two 14- or 16-pin DIP ICs
- Tabs allow multiple units to be connected for larger projects

Simple Motor Controller 24v23

ITEM #1383

\$59⁹⁵



Highly configurable DC motor controller that supports four interface modes: USB, TTL serial, analog voltage, and hobby radio control (RC).

MINIMU-9 v2 Gyro, Accelerometer, and Compass

ITEM #1268

\$39⁹⁵



Provides 9 rotation, acceleration, and magnetic measurements that can be used to calculate absolute orientation.



Premium Jumper Wires

STARTING AT

\$2⁹⁹/pack

Make prototyping connections quickly and easily with these high-quality jumper wires, available with male or female terminations in a variety of lengths and colors.

Jrk 21v3 USB Motor Controller

ITEM #1392

\$49⁹⁵



Highly configurable motor controller that offers four control interfaces and can optionally be used with feedback for closed-loop speed or position control. Great for use with our linear actuators or making your own servo!

SAVE \$20
on orders over \$100
Coupon Code:
NV092013



37D mm Metal Gearmotors

\$24⁹⁵

Other sizes available

- Several gear ratios stocked
- Versions with integrated encoders also available

Dual VNH5019 Motor Driver Shield for Arduino

ITEM #2502

\$49⁹⁵



Control two brushed DC motors with an Arduino or Arduino-compatible board. Operates from 5.5 to 24 V and can deliver a continuous 12 A (30 A peak) per motor.



Linear Actuators

STARTING AT

\$66⁹⁵

Various sizes available

- 2" to 12" stroke lengths
- Multiple speeds available
- Potentiometer feedback option

QTR-L-1RC Reflectance Sensor

ITEM #2455

\$4⁹⁵/2-pack



Add line sensing or proximity/edge detection to your robot with these tiny sensors, capable of measuring infrared reflectance at distances of up to 1 inch.

Zumo Robot for Arduino (Assembled with 75:1 HP Motors)

ITEM #2506

\$99⁹⁵

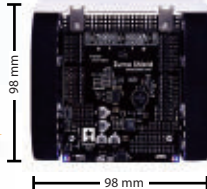
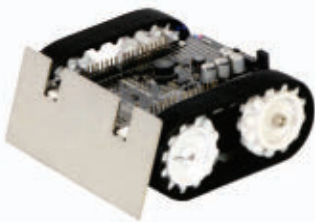

Build and customize your Zumo!

Individual parts and kit version also available — build your own configuration!

- Two micro metal gearmotors coupled to a pair of silicone tracks
- Stainless steel bulldozer-style blade
- Array of six infrared reflectance sensors for line following or edge detection
- 3-axis accelerometer and magnetometer
- Buzzer for simple sounds and music

Dagu Wild Thumper 6WD Chassis (With 75:1 Steel Gearboxes)

ITEM #1563

\$249⁹⁵



- Rugged aluminum body
- All-terrain suspension
- Available in 4WD and other gear ratios and colors

Dagu Rover 5 Tracked Chassis

ITEM #1550

\$49⁹⁵

- Durable rubber tracks
- Adjustable ground clearance
- Available with encoders



5" Robot Chassis RRC04A

\$7⁹⁵

- Laser-cut acrylic base plate
- Many colors available
- Add motors, wheels, a ball caster, and a controller to build a complete robot





by Bryan Bergeron, Editor

DEVELOPING PERSPECTIVES

Nostalgia and the Amnesia of Time

I make a habit of attending the MIT flea market, held in Cambridge once a month in the summer and fall. I always find what I'm looking for: feelings of nostalgia. There's inevitably someone selling a HeathKit transmitter, a Simpson multimeter, an analog Tektronix o'scope, or some other equipment like the ones I either used to own or longed for. Now, I can afford to buy just about anything at the market, but I don't have the time to devote to refurbishing something that went out of production a few decades ago.

Life was certainly simpler when a receiver contained just a pair of transistors or (like a CW transmitter) only a single tube. Electronics were certainly more rugged when everything was built on a steel or copper chassis, but not necessarily better. Take the flash bulbs in the accompanying **photo**, for example.

The bulb in the foreground — about the size of a refrigerator bulb — is all set for ignition. The one in the background is recently fired. Both are built like tanks. Prior to igniting the bulb with a 6V battery, I dropped it onto a hardwood floor from about three feet. It just bounced. Trouble is, now I have to dispose of that bulb. Who knows what heavy metals are on the other side of the glass? Like



those old receivers and transmitters built on a steel chassis, indestructible isn't always a good design goal.

While I sometimes long for the simpler days when perhaps two dozen discrete components could be used to create just about anything, I also remind myself that there were real limits to what could be accomplished. A tube-type guitar amp was certainly easier to fix than a modern solid-state amp, but there were few — if any — onboard special effects. Plus, replacing the output tubes every three or four months was expensive.

I think that time has smoothed the rough edges of the older electronics technologies. Point-to-point wiring was fun, easy to trace, and allowed the components to cool by airflow. There was little that could be done for miniaturization, however. Some innovations are just cool because they provided a glimpse of things to come. Take the first Motorola walkie-talkies. These payphone-sized devices paved the evolutionary path to modern cell phones.

Nostalgia aside, is there any practical value in re-examining the electronics of yesteryear? Of course. There are lessons to be learned about layout, construction, safety (especially around high voltage), and even recycling. If you're designing ruggedized equipment, why not learn from all the years of engineering that went into those bulky — but tough — circuits? If you're designing for longevity, consider the progression of component failure in 'ancient' circuits.

For example, modern high-end tube amp manufacturers avoid ordinary audio-grade electrolytic capacitors in favor of sealed, computer-grade capacitors that have life expectancies of 100+ years. If you've ever refurbished a tube-type audio amp, you know that the electrolytic capacitors are the first components to go.

We'll continue to feature nostalgic circuit projects in *Nuts & Volts*. Even if the electronics discussed predate your parents, I think you'll find them worth reading. Some of the lost arts are worth remembering. **NV**

Published Monthly By
T & L Publications, Inc.

430 Princeland Ct.
Corona, CA 92879-1300

(951) 371-8497

FAX (951) 371-3052

Webstore orders only 1-800-783-4624

www.nutsvolts.com

Subscriptions

Toll Free 1-877-525-2539

Outside US 1-818-487-4545

P.O. Box 15277

North Hollywood, CA 91615

FOUNDER/ASSOCIATE PUBLISHER

Jack Lemieux

PUBLISHER

Larry Lemieux

publisher@nutsvolts.com

ASSOCIATE PUBLISHER/ VP OF SALES/MARKETING

Robin Lemieux

display@nutsvolts.com

EDITOR

Bryan Bergeron

techedit-nutsvolts@yahoo.com

CONTRIBUTING EDITORS

Jeff Eckert

Russ Kincaid

Joe Pardue

Fred Eady

Jon McPhalen

Paul Verhage

Ron Anderson

Thomas Henry

Derek Tombrello

CIRCULATION DEPARTMENT

subscribe@nutsvolts.com

SHOW COORDINATOR

Audrey Lemieux

MARKETING COORDINATOR WEBSTORE

Brian Kirkpatrick

sales@nutsvolts.com

WEB CONTENT

Michael Kaudze

website@nutsvolts.com

ADMINISTRATIVE ASSISTANT

Debbie Stauffacher

PRODUCTION

Sean Lemieux

Copyright © 2013 by T & L Publications, Inc.

All Rights Reserved

All advertising is subject to publisher's approval. We are not responsible for mistakes, misprints, or typographical errors. *Nuts & Volts Magazine* assumes no responsibility for the availability or condition of advertised items or for the honesty of the advertiser. The publisher makes no claims for the legality of any item advertised in *Nuts & Volts*. This is the sole responsibility of the advertiser. Advertisers and their agencies agree to indemnify and protect the publisher from any and all claims, action, or expense arising from advertising placed in *Nuts & Volts*. Please send all editorial correspondence, UPS, overnight mail, and artwork to: 430 Princeland Court, Corona, CA 92879.

Printed in the USA on SFI & FSC stock.



READER FEEDBACK

Camera Project Back In Focus

Regarding Michael Wieckowski's July 2013 article:

One of the projects on my list is a control for my camera; in particular, a motion sensing trigger to capture animals at night. I already have a cable release and an intervalometer – the first mainly to have a

connector that fits the camera body. So, I read Michael's article with interest, and measured my camera's shutter properties including which wire was which. I'm glad he introduced me to BlueGiga and the TI regulator. I'm using a similar part from Microchip (the MCP1640D).

Continued on page 26

ALL ELECTRONICS CORPORATION

2-8 VDC MINI-MOTOR

Mabuchi # FF-030PA 08250.

Body: 15.5 x 12 x 20mm long.

Shaft: 1.5mm diameter x 6mm long.

CAT# DCM-433

100 for \$1.05 each **\$1.25 each**



BULKHEAD MOUNT JUNCTION BOX

2.54" square x 1" junction

box. Black, break-resistant

ABS plastic. Tight-fitting,

lap-joint lid with counter-sunk screws.

Mounting flanges with holes on 3" centers.

There is a 0.5" diameter hole one side, and a 1.5" x 0.25" slot in the rear of the box.

CAT# MBF-30

10 for \$1.50 each **\$1.65 each**



N-CHANNEL MOSFET

International Rectifier # IRF540NS.

100V, 33A, 44M Ohms.

Surface-mount package.

CAT# IRF540NS

10 for \$1.10 each • 100 for 95¢ each **\$1.20 each**



20 AMP CIRCUIT BREAKER

Potter & Brumfield W28-XQ1A-20.

Push-to-reset. Single pole,

panel mount circuit breaker.

20A rating @ 32Vdc/250Vac.

CAT# CB-2820

10 for \$1.60 each **\$1.75 each**



SNAP-ACTION SWITCH W/ LEVER, USED

Defond S.P.D.T. snap-action

switch. Rated 6A 125Vac,

20 x 10 x 6mm. Metal lever.

Solder terminals, two are soldered

and covered with heat-shrink tubing.

UL, CSA. CAT# SMS-303U **50¢ each**



40MM X 44MM THERMO-ELECTRIC COOLER

New thermoelectric devices, prepped with a temperature cutoff switch.

Originally intended for 12Vdc use in picnic and automotive coolers/ heaters.

CAT# PJT-7

10 for \$13.75 each **\$14.75 each**



3PDT PUSHBUTTON SWITCH

Push-on/ Push-off. Commonly used as a guitar effects foot pedal switch.

12mm dia. threaded bushing.

Mounts in panels up to 10mm thick.

Solder-lug terminals.

CAT# PB-323

\$3.75 each



SOLAR CELL

Output: approximately 3 Volts

@ 40 mA. 60mm square x

2.5mm thick epoxy-encapsulated

silicon photovoltaic cell.

Solderable foil strips on backside.

CAT# SPL-61

100 for \$3.25 each **\$3.75 each**



3-PRONG GROUNDING AC PLUG

Leviton# 515PR.

Black 15 Amp grounding

3-wire AC plug. Rubber

body is dirt and moisture resistant. Tough

elastomeric husk. Built-in cord grip adjusts

to 0.245" to 0.655" cords, 18-3 to 12-3.

UL, CSA. CAT# ACP-8

10 for \$2.50 each **\$2.75 each**



12VDC 1.25A POWER SUPPLY

YHI# 898-1015-U12S.

Input: 100 - 120 Vac, 60 Hz,

600 mA. Output: 12 Vdc

1.25 A. 5' output cord with

2.1mm coax power plug and

ferrite bead. Tip+.

CAT# PS-12125

\$9.95 each



ORDER TOLL FREE 1-800-826-5432
www.allelectronics.com

Discuss these topics at <http://forum.nutsvolts.com>.

ADVANCED TECHNOLOGY

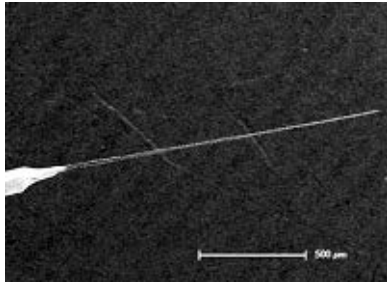

■ Brain cell harpoon developed at Duke University.

Harpoon Your Brain

If you want to monitor overall brain activity, the standard way is to strap a headset on the victim, hook him up to an electroencephalography (EEG) apparatus, and watch what comes through the channels. Sometimes, though, scientists want to study interactions between individual neurons to, e.g., better understand the computational complexity of the brain. That can be a little tricky as it involves inserting tiny electrodes into the cells, and existing ones have some shortcomings. Metal electrodes record spikes but can't record the computations performed by the cells. Glass probes can do both but are fragile and can break off, leaving your brain full of little shards.

Recently, a couple of professors at Duke University (duke.edu) constructed a brain cell "nano-harpoon" out of increasingly ubiquitous carbon nanotubes. The result is an improved probe that is only a millimeter long and a few nanometers thick.

"To our knowledge, this is the first time scientists have used carbon nanotubes to record signals from individual neurons — what we call intracellular recordings — in brain slices or intact brains of vertebrates," noted Prof. Bruce Donald, one of the probe's developers. "The new carbon nanotubes combine the best features of both metal and glass electrodes. They record well both inside and outside brain cells, and they are quite flexible. Because they won't shatter, scientists could use them to record signals from individual brain cells of live animals," added Duke neurobiologist Michael Platt.

To make the probe, they started with the tip of an electrochemically sharpened piece of tungsten wire and extended it with self-entangled multiwall carbon nanotubes, which were further sharpened using a focused ion beam. They then jabbed it into mouse brains to demonstrate that this type of probe works at least as well as its glass counterparts — so well that the team has applied for a patent. According to the developers, the probes may be useful in applications ranging from basic science to human brain-computer interfaces and brain prostheses. ▲

Small Size, More Power

Also on the tiny side is a new microbattery developed by a research team from Harvard's Wyss Institute (wyss.harvard.edu) and the University of Illinois at Urbana-Champaign (illinois.edu). There has always been a tradeoff between the size of a battery and the amount of power it can provide, which is a limitation for many miniaturized devices such as flying insect-like robots, built-in microphones and cameras, and other gadgets for which weight is critical. One approach is to create very thin, lightweight batteries using thin-film deposition techniques. Because they are super thin, they just don't pack enough power for many designs. The Harvard/Illinois team reasoned that, if they could come up with inks that have the right combination of chemical and electrical properties, it would be possible to create more powerful batteries using 3D printing techniques. Turns out they were right.

They concocted one ink for the anodes and another for the cathodes — each containing a different lithium metal oxide compound. These were deposited as layers on two gold combs to create an interlaced stack of anodes and cathodes. Then, all they had to do was drop the electrodes into a container and fill it with electrolyte. The result is functioning lithium-ion microbatteries the size of a grain of sand.

According to one of the team members, "The electrochemical performance is comparable to commercial batteries in terms of charge and discharge rate, cycle life, and energy densities. We're just able to achieve this on a much smaller scale." This breakthrough should be useful in the development of many types of smaller devices in medical and other fields. ▲

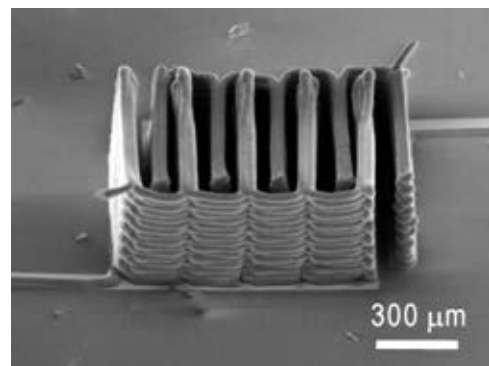

■ A Harvard/University of Illinois team creates the first 3D printed microbattery.

COMPUTERS and NETWORKING

Need Another Mobile OS?

If you are of the opinion that — even with Apple iOS, Android, Windows Phone, BlackBerry OS, and others — there still are not enough mobile operating systems in existence, you'll be happy to note that smartphones employing Mozilla's (www.mozilla.org) Firefox mobile OS are beginning to appear, initially in lower-cost phones and emerging markets. The ZTE Open smartphone is already on sale in Spain, and Alcatel soon will be offering its One Touch Fire unit with the Firefox OS. As of this writing, Sprint has announced plans to release a related product, but so far the commitment has yet to translate into a product.

According to Mozilla, "Firefox OS includes all the things people need from a smartphone out of the box — calls, messaging, email, camera, and more — as well as the things you wish a smartphone offered. Firefox OS also includes built-in social features with Facebook and Twitter, HERE Maps with offline capabilities and smart walking, driving, and public transit directions, much-loved features like the Firefox Web browser, a new ability to discover one-time use and downloadable apps, Firefox Marketplace, and much more." The organization claims that "operators, OEMs, and developers" are showing keen interest in this open source alternative platform that —



■ The Alcatel One Touch will offer the Firefox mobile OS.

being based on a web browser — is more Web friendly and can run HTML5 apps. Many observers aren't convinced that the world needs it, however, or even that it will be possible to slip into an already crowded market. Either way, you can watch the official demo at www.youtube.com/watch?v=lu8q-olSbas&feature=youtube. ▲

Free Secure Browsing

While your standard garden-variety browser comes with an optional setting for "private browsing," we all know that it isn't really all that private. Some sites manage to set cookies in spite of your settings, and because your IP address is readily detectable, they can tell if not exactly who you are, pretty close to where you are; plus, what kind of computer and software you are using, and some other information. That's why you get customized ads telling you about the homemakers in your neighborhood who make \$3,000 a week tasting bran muffins. If you really want to browse anonymously, you need to go through a proxy server so your IP address isn't detectable. If you want to be nearly impossible to trace, you need to go through an entire network of proxy servers. That sounds complicated but, in fact, you just need to download the Tor browser from www.torproject.org, install it, and start surfing.

Tor ("The Onion Router") was designed as a project of the US Naval Research Laboratory and is an adaptation of Firefox. Be aware that: (1) no browser is 100 percent anonymous, but this comes pretty close; and (2) you will experience noticeably slower data transfers because of all the "virtual tunnels" that the signals traverse. Right now, the Internet thinks my machine's IP address is 78.108.63.44, which places me in Vallentuna, Sweden which is a bit north of Stockholm. I'm pretty sure that is incorrect. The browser is free and available for Win32, Mac OS X, and Linux/BSD/Unix. You are encouraged, however, to donate to the project if you like it. ▲



■ The Tor browser uses multiple proxy servers to provide anonymity.

COMPUTERS and NETWORKING continued

Are You Ready for Virtual Money?

If you are among the folks who believe that the USA should go back on the gold standard or if you believe that money has value only if "backed" (whatever that means) by a fiscally responsible national government (assuming you can find one), this concept will not sit well. If you're a bold speculator/anarchist/dealer in contraband, online gambler, or a resident of a country whose currency is swirling down the toilet, you might be interested in the Bitcoin – a digital crypto-currency that exists outside of the world of central banks and governments.

Created in 2009 by someone who goes by the pseudonym of Satoshi Nakamoto, it is basically a totally anonymous peer-to-peer payment system. Bitcoin transactions are secured by military-grade cryptography, are recognized internationally, and cost relatively little. Like other currencies, each Bitcoin is subdivided – in this case, down to eight decimal places – which gives you 100 million "satoshis" per coin. Bitcoins are created by the Bitcoin Project (bitcoin.org), but they are distributed

through exchanges.

Although it seems like something of a Ponzi scheme (and it could work out that way in the end), the monetarist economists among us will at least like the fact that the existing number of Bitcoins in virtual existence has a strict, self-imposed limit of 21 million, and it won't reach that number until 2140. This means that the currency will not be subject to Federal Reserve-style inflation. The value of a Bitcoin is based only on its perceived value in the market, so one might expect it to fluctuate wildly. And one would be correct. On April 10, for example, it opened at \$230, shot up to \$266, then dropped to \$105 and closed at \$165. Right now, you can buy one for \$77. As an investment, this is not for the faint of heart.

In any event, if you want to get involved, you first need to set up a virtual wallet to hold your funds and trade some dollars for Bitcoins. There are several places to do that, but Mt. Gox (mtgox.com) handles about 80% of the world's exchanges. You're then ready to start buying things, or you can just hold onto your Bitcoins in the hope that they will become more valuable. ▲

CIRCUITS and DEVICES

Better Smartphone Pix

One of the limiting factors in taking high-quality photos with your smartphone is the flash driver which typically puts out only about 2A to drive the LED. However, ams AG (www.ams.com) has figured out a way

to boost that to 8A by incorporating a Murata supercapacitor called an electric double layer capacitor (EDLC).

Driving two LEDs in series with power from the supercap – as well as the phone's battery output – the output is boosted to better than 9V to match the forward voltage of the LEDs. This allows faster shutter speeds, allowing sharper images and a less blurry capture of fast-moving objects. No details were provided about what smartphones will be incorporating the AS3630 drivers, but price shouldn't be an obstacle. The devices are priced at just \$2.19 in quantities of 1,000. ▲

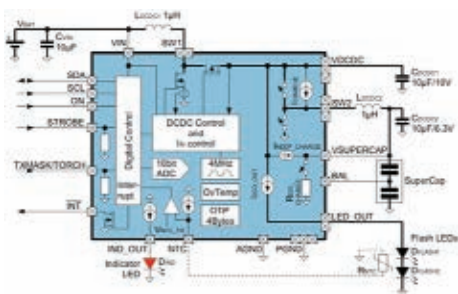

■ Block diagram of the ams AS3630 photo flash driver.

High-End Ear Buds

For years, Cardas Audio (www.cardas.com) has been manufacturing premium audio cables and other components for audiophiles. As the story goes, a few years ago, George Cardas was designing cables for a major headphone vendor but was unimpressed by their overall product. So, naturally, George decided to design his own headphone line. The result is the model EM5813 ear speakers – billed as "efficient, natural, musical, and the result of years of meticulous design ..."

According to the company, new insights into magnetics and metallurgy have produced a custom driver with unmatched performance. The units – made in Connecticut and California – employ the company's Clear Light Headphone Cable, featuring a special matched propagation technology. The ear speakers can be plugged into a portable headphone amplifier or connected directly to a smartphone or media player using the gold-plated plug and 60 inch (1.52 m) cable.

Technical specs are hard to come by, but it is said that the units are designed to mimic the human cochlea and tympanic membrane to produce superior sound. They do come with two sets of tips: standard and bass limiting. Early reviews are highly favorable, as they should be for a pair of ear buds that cost \$425. ▲



■ Exploded view of Cardas Audio's EM5813 ear speaker.

INDUSTRY and the PROFESSION

Don Matrick Jumps Ship

You may not be familiar with Zynga (zynga.com) unless you are a gamer, but Facebook users will know the company as the originator of Facebook's FarmVille game. Zynga started out as a hot entity in 2009, with its games drawing 10 million daily active users. The stock began trading at \$10 in 2011 and hit \$14.50 in 2012, but nose-dived to \$2.09 later that year. It has since recovered to a recent \$3.42, but the company's long-term prospects are in question, and it has laid off 500+ employees to reduce operating costs.

In an effort to turn things around, the company recently recruited its new CEO Don Matrick away from Microsoft with a \$5 million signing bonus and stock options valued at \$40 million. Ironically, Bloomberg has reported that Matrick had long been interested in buying Zynga, but, hey, why pay money for something when they'll pay you to take it? **NV**

Imagine this...

- a small and inexpensive
- USB or ethernet device
- with a rich set of features
- including PLC functionality and 3-axis stepper motor controller
- all accessible via free .NET, ActiveX or C++ library
- cross-platform
- configurable with free software

PoKeys



Or this...

- Smallest USB 2.0 portable 1MS/s oscilloscope
- Data acquisition of analog and digital signals
- Data recording
- Export to CSV, XLS, PDF and HTML
- Simple usage of advanced features
- Examples for C++, VB, Delphi and LabView
- Free software and updates

PoScope Mega 1+

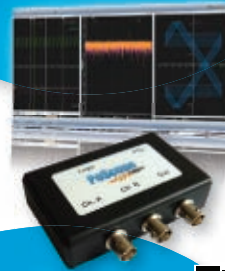

PoLabs



Visit us at

www.poscope.com

The 2013 Great Plains Super Launch



Go to www.nutsvolts.com/index.php?/magazine/article/september2013_NearSpace for any additional files and/or downloads associated with this article. You can also discuss this topic at <http://forum.nutsvolts.com>.

The Great Plains Super Launch (GPSL) 2013 met in the Vermeer Science Center of Central College in Pella, IA. Mike Morgan (N0MPM) and Jim Emmert (WB0URW) of Pella Explores Near Space (PENS) hosted the conference. Their planning began in late 2010.

This year's Great Plains Super Launch took place in Pella, IA — a town proud of its Dutch heritage. One of the town's landmarks is the Vermeer windmill which is the largest Dutch windmill in the United States. It's a working windmill that grinds flour for a local business (Jaarsma Bakery). You learn a lot about technology by visiting the Vermeer Mill. The same can be said when you attend the GPSL.



Pella is a town with hospitality. Many stores in the city square posted greetings like this.

Thursday, June 13, 2013

This year's conference informally began on Thursday, June 13th with tours of Vermeer Manufacturing Company and Pella Corporation. Vermeer is an international manufacturing company that produces equipment for farms (like round hay balers) and roads (like the world's largest road leveler).

Most people know the Pella Corporation for their high-end windows.

After touring these factories, many attendees retired to dinner at George's Pizza and Steak House. That was followed by a public concert in the town square.

Friday, June 14, 2013

Friday's events began with check-in and a light breakfast. I was pleasantly surprised when Dr. Bob Leonard asked to interview Mike and me for his radio program — **In Depth** — on radio stations KNIA and KNLS. Mike and I took advantage of the opportunity to acquaint radio listeners with near space and its educational benefits.

There were six presentations and one demonstration at GPSL this year. Dr. Howard Brooks of DePauw University and two of his students gave the first presentation. They discussed their experience designing and flying multiwave photometers.

Attendees learned that these students were designing and flying BalloonSats with photometers in an effort to measure the intensity of sunlight as a function of altitude. One of their references for this project was an article I wrote about LED-based photometers for *Nuts & Volts*.

Next up was me. I presented on near space STEM (science, technology, engineering, and mathematics). The audience learned about two near space launches I did for the Bellevue School District (Washington) this spring and the data I hoped to collect. As it turns out, I'm still in the process of collecting data from 114 students in two states.

I also described two BalloonSat activities I'm designing for implementation in Idaho. First are the BalloonSat classes I'm preparing to teach through community education in both Boise and Twin Falls. The classes will be similar to a robotics class I taught through community education this spring.

I also shared my plan to bring additional STEM educational opportunities to Idaho students through the Idaho Space Grant Consortium. This project doesn't bring BalloonSats and near space activities directly to students. Instead, it's a program that shows teachers how to incorporate BalloonSats into their curriculum.

Our third presenter was Dr. Matthew Nelson. He brought a national educational ballooning organization to our attention. Model rocketry has NAR and Tripoli, while model aircraft has AMA. At this time, however, no national organization for amateur near space explorers exists. Dr. Nelson shared with us several reasons why an educational organization might be useful to amateurs like us.

First was the possibility of insurance for our activity, and second was the voice it gave to us during discussions about changes in federal regulations affecting our activity. As in years past, there was

some disagreement about the importance of a national organization to the amateur community.

After Dr. Nelson's presentation, we took a break for lunch and a demonstration of the vacuum cannon by your humble author. Vacuum cannons are amazing for their simplicity and capability.

A vacuum cannon is a PVC tube containing a ping pong ball and is sealed at both ends with Mylar film. An inexpensive vacuum pump then removes the air inside the PVC tube. When the Mylar film located on the end opposite the ping pong ball is cut, air rushes in creating pressure on one side of the ball. That pressure generates a force of around 20 pounds that accelerates the seven gram ping pong ball at over 100 gees.

The result of this acceleration is that after a distance of five feet, the ping pong ball breaks out of the other Mylar film with a bang traveling at approximately 300 miles per hour. Even a low mass ping pong ball will rip through an empty aluminum can if it's traveling that fast. Now, that's what I call a demonstration of the power of a vacuum.

After lunch, Bill Brown from Huntsville, AL gave a presentation on long duration balloon flights and telemetry modes. Both Bill and the California Near Space Project are known for their long duration balloon flights. They have demonstrated several times that a latex weather balloon launched near evening and with just enough lift to carry a small payload can drift across the United States and the Atlantic Ocean before bursting.

Bill's telemetry modes include some that transmit at low radio

frequencies. These HF signals are capable of traveling much farther than the higher frequency signals that most of our near space payloads use. That increased range makes these lower frequency modes ideal for long duration flights.

Our next presenter was Michael Willett of ARBONET (Amateur Radio Ballooning Over North East Texas). Like me, he is focusing a lot of his effort on using BalloonSats as a tool for STEM education in school. Michael then shared his thoughts on using solar power for near space flights.

One limitation on long duration flights is their power requirement. If the balloon remains airborne long enough, the batteries supplying power to its payload are bound to die. As Michael explained, using solar power wisely is one way to get around this limitation.

Jim Emmert gave the final presentation. His topic was about an amazing animal called the Tardigrade, or water bear. These tiny one millimeter-long creatures can survive extreme conditions like intense cold, high vacuum, and lethal doses of radiation by entering into a state called tun. It's a hibernation state in which the Tardigrade's body dries out. Jim's students want to experiment on Tardigrades by launching them into near space.

The presentation portion of GPSL closed with a weather report and flight prediction given by meteorologist Mark Conner of NSTAR (Nebraska Stratospheric Amateur Radio). There was concern earlier in the week that we would cancel the launch portion of the conference because of the amount of rain Pella was experiencing.

Pella was settled in 1847 by 800 Dutch immigrants looking for religious freedom. It's also the home of Wyatt Earp — a gunfighter at the OK Corral. Every May, Pella holds the Tulip Festival. Where else can you purchase a pair of wooden shoes and go dancing in town?

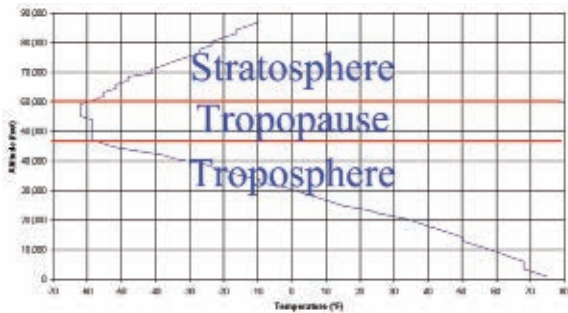

FIGURE 1. The sensor used in this experiment is an LM335 temperature sensor. It behaves like a temperature-controlled zener diode and produces a voltage proportional to its temperature. Its output voltage was digitized using the eight-bit ADC command found in a PICAXE.

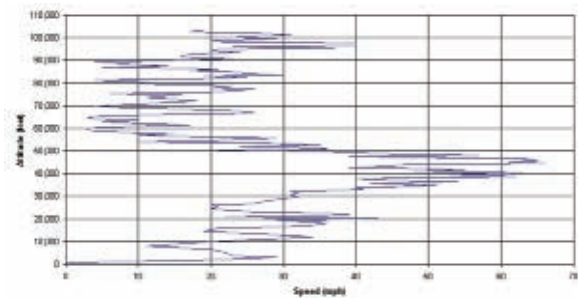

FIGURE 4. A GPS receiver can be a sensor of sorts. Two pieces of data coming out of it are the speed and altitude to the GPS receiver. Since the GPS is firmly attached to the balloon and the balloon is a captive to the wind, the GPS indicates the speed and direction of the wind.

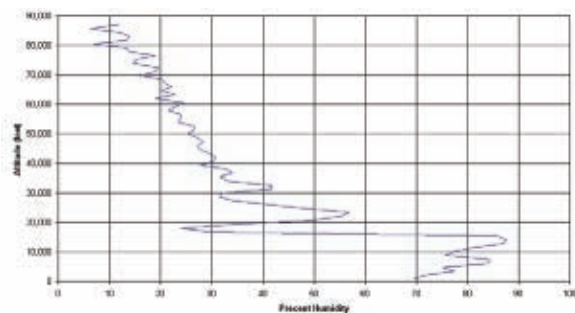
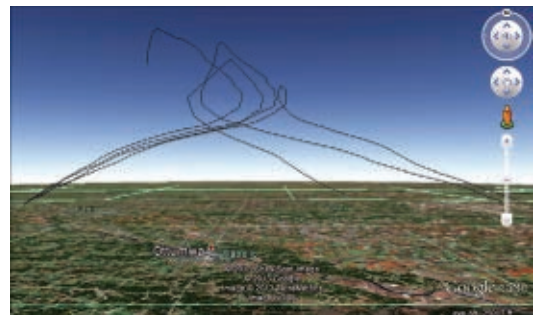

FIGURE 2. This data was collected using a Honeywell HIH-4000 relative humidity sensor. Like the LM335, it produces a voltage proportional to the relative humidity.



The flight path of the four NearSys missions is shown in this Google Earth image. Notice that the direction of the balloons switched above flight level 600 (60,000 feet). As a result, balloons climbing higher took longer to complete their mission but landed closer to Pella. Both GPS trackers used on NearSys 13E failed during its flight which is why its flight path ends early in descent. It wasn't difficult to recover the flight, however, as one of the trackers managed to spit out a position report at an altitude of 5,000 feet.

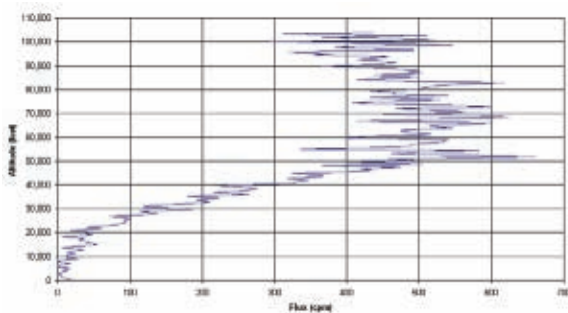

FIGURE 3. One of the best cosmic ray sensors I have found is the Aware Electronics RM-60. It runs off of five volts and produces a five volt pulse when it detects a passing cosmic ray. The PICAXE's COUNT command collected the data displayed in this chart.

Mark was able to give us good news during his briefing; we had a rain-free window suitable for launching on Saturday morning. We then finished Friday by preparing near spacecraft and attending a dinner.

Saturday, June 15, 2013

The launches Saturday morning took place in a parking lot at Vermeer Corporation. NearSys launched four balloons Saturday — a record for the number of launches by a single person or organization. Launching that many balloons meant I spent a lot of time running from one balloon to another preparing them for filling. However, once the balloon filling began, I tended to stay with each balloon until it was launched. I want to thank Mark Conner (N9XTN), Bill Brown (WB8ELK), Keith Kaiser

(WA0TJT), Mike Moody (KD0MEQ), and Pete Lilja (KC0GPB) for sharing balloons and hydrogen with me.

Data Collected

The four NearSys flights reached altitudes of 67,000, 87,000, 93,000, and 103,000 feet. I programmed three of the missions to collect data and would like to share some of those results with you.

Figure 1 is a good example of atmospheric temperature change. It illustrates how the location of the troposphere, stratosphere, and the boundary between them — the tropopause — are defined by their temperature changes.

Initially, the temperature of the air decreases as the balloon climbs

higher in the troposphere. That's because the troposphere is transparent to sunlight and heated primarily by its contact with the ground. The stratosphere does the opposite and becomes warmer with increasing altitude because it contains the ozone layer. Ozone is not transparent to ultraviolet; it absorbs this radiation and converts it into thermal energy. Between the troposphere and the stratosphere is a pause in the change of temperature and it's called the tropopause. Often, I do not see the tropopause so prominently displayed in my data.

Figure 2 shows just how humid Saturday morning was. The clouds topped out at around 15,000 feet and as you can see, the air was dry above them.

Many NearSys missions carry Geiger counters and GPSL was no exception. **Figure 3** illustrates how the lower atmosphere shields us from cosmic radiation which consists mainly of protons from outer space. The subatomic particles in cosmic radiation collide with molecules in the atmosphere to create showers of lower energy subatomic particles. The denser air eventually absorbs most of this shower of secondary radiation.

As you can also see in **Figure 3**, as the balloon climbed higher there was less shielding atmosphere above the balloon, so the cosmic ray count increased. Notice, however, that at above 60,000 feet the count begins decreasing.

This occurs because the Geiger counter is beginning to detect primary cosmic radiation before it has a chance to create secondary cosmic radiation. Looking at this data, do you see a hint that the cosmic ray count is trying to increase above an altitude of 100,000 feet?

The reported speed and altitude of the onboard GPS receiver created the chart in **Figure 4**. The chart shows there was a mild jet stream over Pella during GPSL. Even better (although not shown in this chart),



NearSys 13E and NSTAR Flight 13-A as they were found on the ground. A wet spring meant Iowa farmers planted their corn later than usual. That's why the corn isn't hiding the near spacecraft as it normally does. The recovery site was 20 feet off the road and we would have missed it had it not been for the sharp eyes of Mike Moody.

the winds above 60,000 feet reversed their direction and went from east to west. That meant balloons traveling longer and higher landed closer to the launch site.

I always enjoy attending GPSL. It's a conference I helped begin in 2001, and I am the only person to attend each one. Next year, Project:

Traveler will host GPSL (Zack Clobe's third time) in Hutchinson, KS. I invite *Nuts & Volts* readers to attend this conference to learn about near space technology and how balloons are launched. You can remain current with Great Plains Super Launch plans at <http://superlaunch.org>.

Onwards and Upwards,
Your near space guide **NV**

In this column, Russ answers questions about all aspects of electronics, including computer hardware, software, circuits, electronic theory, troubleshooting, and anything else of interest to the hobbyist. Feel free to participate with your questions, comments, or suggestions. Send all questions and comments to: Q&A@nutsvolts.com

- ESD Instrument Circuits
- More About Making Sparks
- VFO Design

Go to www.nutsvolts.com/index.php?/magazine/article/september2013_QA for any additional files and/or downloads associated with this article. You can also discuss this topic at <http://forum.nutsvolts.com>.

ESD Instrument Circuits

Q I have looked for used ESD (electrostatic discharge) instruments on eBay with little success. I have also been unsuccessful at finding circuits for these handheld instruments.

At this point, I would like to make the following, but need a source for circuits:

Surface resistance tester (100 VDC with order of magnitude resolution in ohms per square to beyond a teraohm); Static field meter (roughly ± 50 -10,000V, compatible with a charge plate that I will build); and Deionizing circuit for an air nozzle (either AC or chopped DC).

I have substantial experience using this equipment, and want to integrate it into my home lab. I just don't want to start from scratch with design due to time constraints and concerns over the safety aspects of making the voltages necessary to accurately measure surface resistance, and to generate positive and negative ions.

Given the ever decreasing line-to-line spacing in ICs (leading to less than 50V sensitivity for many new designs), I would think this would be a popular set of equipment to make.

— Bob Crain

A I will present my idea for a surface resistance tester here and work on the static field meter and deionizing circuit for a later column.

The probes for the tester should be spherical so as not to penetrate the surface, and should be gold or nickel plated for good contact. Surface resistance will read the same regardless of where you probe, providing the probe is not near an edge and the probes are close together relative to the size of the total area. I'll assume probes of 10 mils diameter spaced one inch apart will be used.

I had to look up what a teraohm is; it is 10^{12} ohms. The design could use constant current and measure the voltage, or constant voltage and measure the current. If the voltage is limited to 100V, the current is $10^2/10^{12} = 10^{-10} = 100$ picoamps. I want to use an AC source because I don't want to deal with a high gain DC amplifier. I think a voltage source will be easier to make than an AC current source.

The frequency will be 20 kHz in order to be inaudible and low enough that inexpensive op-amps can be used. The signal source is shown in **Figure 1** and is a SwitcherCAD simulation circuit. All the transistors are available from Mouser. I did not have an op-amp capable of full output at 20 kHz, so I built one.

The first stage is a "long tail pair" which has wide bandwidth and low distortion. Q5 provides rail-to-rail signal, and Q6 and Q7 provide the drive to the following stages. R4 and R3 give positive feedback to produce

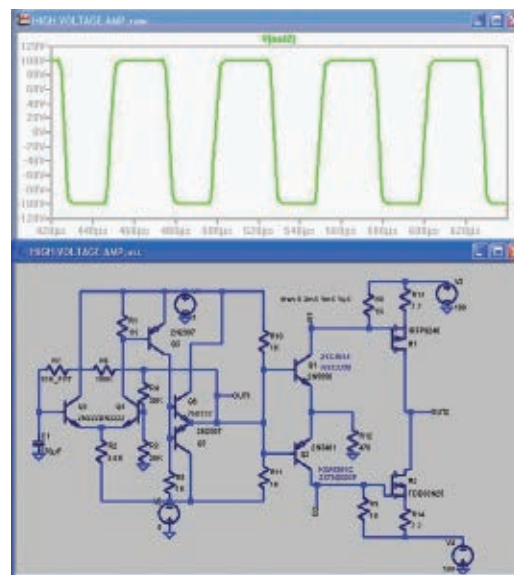

■ FIGURE 1.

plus and minus two volts of hysteresis. Negative feedback through R6, R7, and C1 makes it an oscillator.

Q1 and Q2 are high voltage transistors to drive the MOSFET gates. The current is limited by R12 to about 8 mA peak; $8 \text{ mA} * 100\text{V} = 0.8$ watts, but it is only driving half of the time so the transistors should be okay. There is a shoot through current in the output transistors which is limited by R13 and R14 to less than two amps.

Figure 2 is the probe circuit. The sense resistor is 100K for teraohm sensitivity which generates a voltage of $100^{-10} * 100^3 = 100^{-7} = 10 \mu\text{V}$. The first stage is an instrumentation op-amp (INA128) with a gain of 100.

The next two stages are a

MAILBAG

Re: Beginner's Question, July 2013:

Someone who was completely new to electronics asked you what you would recommend to start learning. Coming from a professional, your first answer was Algebra and to continue on with Calculus. Russell, I hate math. Almost just like you, at age 13 my father bought me a "cat whisker" crystal radio kit; it worked and I was hooked. How could this tiny radio play into the night every day with no power? What were those little resistors with the pretty colored stripes? Then, for Christmas I received a RadioShack 300-in-1 Electronics Kit, and my world changed. I made myself an electronic siren, a timer, a metronome, an amplifier, and even a radio transmitter! Almost everything I know and love about electronics was self taught. It is my No. 1 hobby; today, I even design and build my own projects using integrated circuit technology. Plus, of course, *Nuts & Volts* is my favorite magazine!

You know what, Russell? I still hate math!

Frank Alberts III

Math is not a requisite, although lack of it may be a limitation. SPICE is a good tool to learn because it will allow you to fiddle and tweak much faster and easier than with a breadboard. I once designed a circuit that worked but which I was not competent to analyze. I designed and built an oscilloscope with scrounged parts before I went to college, so you can do a lot with common sense and high school math.

Re: Jacob's Ladder Circuit, July 2013:

You were right on in identifying the diode on the primary as a problem. However, recommending higher frequencies is probably off the mark. The problem is the turns ratio of these coils requires about 200 volts to generate adequate spark voltage. In order to get a 200 volt inductive kick, we have to interrupt a sizable current in the primary. Since the inductance of the primary limits the rise time of the current, the 12V must be connected for a reasonable time to let the current build up.

In ignition systems, this was called the dwell time which was set by the angle of rotation of the distributor during which the points made contact. These units tended to have problems at high RPM in any case, which is why capacitive discharge — or solid-state — systems became popular. These units usually incorporated a DC-DC converter to generate about 200 VDC which was then switched onto the primary instead of the 12V in the circuit in question. This provided a faster rise time and thus sufficient current to generate a hotter spark. I would thus recommend the questioner to use a LOWER frequency or use a DC-DC converter to get strong sparks. At 2,000 RPM, an eight-cylinder engine only fires a spark about 133 times per second, so 200-400 Hz would be close to what the coil is designed for.

R.C. Carlson

Thanks for writing; you are so right! Why didn't I think of that?

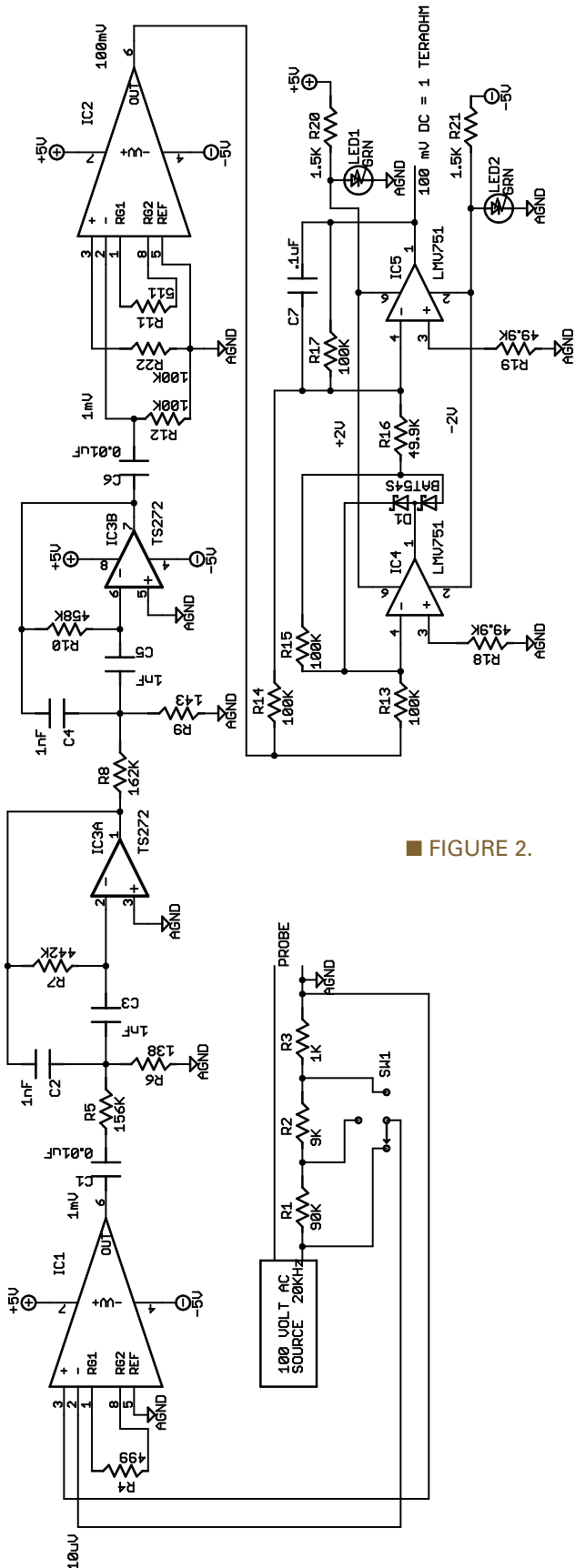

■ FIGURE 2.

would have to be solid-state and operate from a 12 volt DC power source. Each would need to have a frequency range of 25 MHz to 30 MHz, either in a continuous tuning or in 1 MHz bands, and have either a digital readout or an output for a frequency counter. Thank you for your time and help.

— Bradley Flener

A Since it is not legal to operate a VFO outside the amateur frequencies of 28.000 to 29.700 MHz, I have limited this design to those frequencies. The circuit must have good stability relative to vibration and temperature.

I recommend mounting the circuit in a die cast box with a temperature compensating heater to maintain the box at 50 degrees C. Or, alternatively, operate in a

temperature controlled environment.

I simulated the design (**Figure 4**) in SwitcherCAD IV – a free SPICE analysis tool from Linear Technology – and tweaked the L-C values. I was designing around a 3.3 to 23.3 pico-farad variable capacitor that was on eBay.

However, realizing that the capacitor will not be available when this goes to print, I found values for the standard 365 pF variable that is used in AM broadcast radio: C5 = 18 pF; C4 = 27 pF.

The design is standard Colpitts and the value of C7 is not critical; it can vary from 1,000 pF to 3,000 pF. The voltage on the coil is about 100 volts, so C4, C5, C6, and C8 need high voltage ratings. C8 provides isolation of the impedance of Q1 from the tuned circuit to maintain high Q. I tapped the output down on the emitter resistor (R3, R4) for

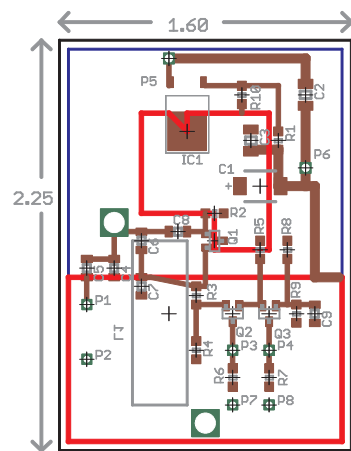

■ FIGURE 5.

added isolation, and used a two transistor amplifier which gives a high degree of isolation of load effects. If the counter and output signals are not equal, you may need to adjust the voltage divider R8, R9.

ezPick
VACUUM
PICK AND PLACE
SYSTEM

ABACOM
TECHNOLOGIES

www.abacom-tech.com

SCOPE DEALS Saelig.com
unique electronics

WORLD'S SMALLEST
World's smallest MSO! This DIP-sized, 200kHz, 2-ch scope includes a spectrum analyzer and Arbitrary Waveform Generator. Measures only 1 x 1.6 inches in size! - XPROTLAB **\$49**

IPHONE SCOPE
5MHz mixed signal scope adapter for iPhone, iPad and iPod Touch! FREE IMSO-104 app available from Apple App Store. - IMSO-104 **\$296.99**

30MHz SCOPE
Remarkable 30MHz, 2-ch 250MS/s sample rate oscilloscope. 8-in color TFT-LCD and AutoScale function. Includes FREE carry case + 3 yr warranty! - SDS5032E **\$299**

60MHz SCOPE
Best selling 60MHz 2-ch scope with 500MSa/s rate + huge 10MSa memory! 8" color TFT-LCD. Includes FREE carry case! - SDS6062 **\$349**

100MHz SCOPE
High-end 100MHz 2-ch 1GSa/s benchscope with 1MSa memory and USB port + FREE scope carry case. New super low price! - DS1102E **\$399**

INCREDIBLE LOW PRICES, FREE TECHNICAL SUPPORT
EXCELLENT CUSTOMER SERVICE WWW.SAELIG.COM

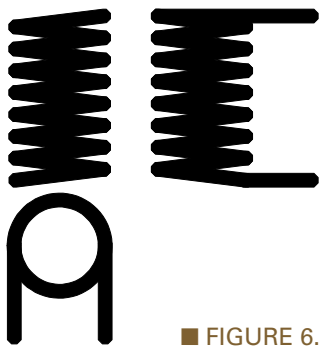

■ FIGURE 6.

Rugged mechanical construction is needed to have an oscillator that does not “microphonically” respond to vibration. That is the reason I used #12 wire for the coil.

The circuit should be enclosed in a metal box for shielding. A feed through capacitor for power — like

10 METER VCO PARTS LIST

■ FIGURE 7.

PART	DESCRIPTION	PKG	MOUSER PART #	COST
IC1	LDO REG, ADJUSTABLE	TO252	726-IFX27001TFV	\$1.52
Q1	MMBT4124	SOT23	512-MMBT4124	0.20
Q2, Q3	MMBTH81	SOT23	512-MMBTH81	0.22
C1	10 μ F, 35V, 10%	7343	80-B45196E6106K409	0.73
C2, C3	0.1 μ F, 50V, 10%	1206	81-GCM319R71H104KA7J	0.27
C4	33 pF, 250V, 5%	0805	581-UQCFVA330JAT/500	1.50
C5	27 pF, 250V, 5%	0805	581-UQCFVA270JAT/500	2.10
C6	20 pF, 250V, 5%	0805	581-UQCFVA200JAT/500	2.10
C7	1,000 pF, 50V, 10%	0805	581-08055A102J	0.10
C8	2.2 pF, 250V, 5%	0805	581-UQCFVA2R2BAT/500	2.30
C9	.01 μ F, 50V, 10%, X7R	0805	80-C0805C103K5R	0.10
L1	500 nH, 2%, 9TURNS #12 ON 1/2 INCH FORM, 1.1 INCHES LONG			
ALL RESISTORS THICK FILM, 1%, 1/8W		0805	71-CRCW0805-VALUE-E3	0.07

Mouser #800-4400-007LF (\$8.33) — would be nice but is pricey. BNC connectors for the outputs should work well.

I made a layout (Figure 5) and generated Gerber files which can be downloaded at the article link in case

anyone wants to build it. Note: The unconnected parts go to the ground plane which is only shown as an outline. Figure 6 is a sketch to show what L1 should look like and Figure 7 is a Parts List. Sunstone Circuits will build one board for \$35.80. **NV**



1-800-543-4330



AUTHORIZED DISTRIBUTOR

MCM Electronics™ Is Your Raspberry Pi Specialist

MCM has a complete selection of Maker/DIY accessories from all your favorite manufacturers



ONLY \$19⁹⁹

Arduino Uno Board
MCM Part #83-13129



ONLY \$35⁰⁰

Raspberry Pi Board
MCM Part #83-14421



\$12⁴⁹

RPI VESA Case
MCM Part #83-14422



\$47⁹⁹

XBMC Bundle
MCM Part #83-14951



\$28⁴⁹

19" Pi Rack Mount
MCM Part #555-15552



\$59⁹⁹

5" Project LCD
MCM Part #83-15138

MCMelectronics.com/Maker

NEW PRODUCTS

- HARDWARE
- SOFTWARE
- GADGETS
- TOOLS

RADIO ONLY RF TRANSCEIVER ALLOWS EFFECTIVE CUSTOMIZATION

The new DP1203 series radio-only RF transceiver module from Linx Technologies is designed for the wireless transmission of digital data at data rates of up to 152.3 kbps.

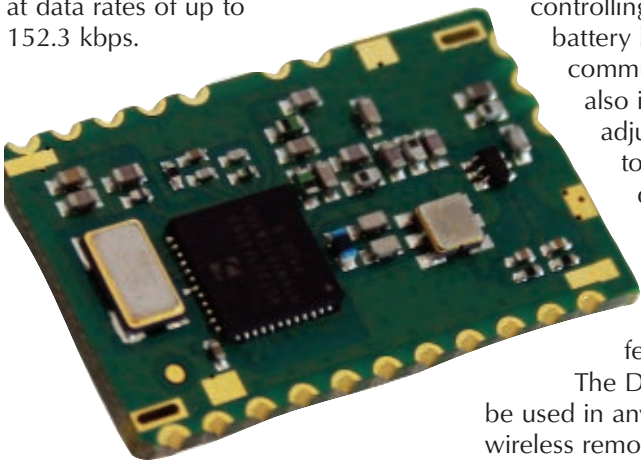

Operating in the 433, 868, and 915 MHz license-free ISM (Industrial, Scientific, and Medical) frequency bands, this module series is ideal for applications that require full control of the radio channels and configuration, without having to go through the effort and expense of a discrete RF design.

The module has a maximum output power of +15 dBm and a receiver sensitivity of -111 dBm. This gives the module a typical line-of-sight range of two to three miles (3.2 to 4.8 km) at maximum output power with typical monopole whip antennas, depending on frequency. Regulations in the country of operation dictate the maximum legal output power so the final system range may be less, depending on the country of operation.

The DP1203 series transceiver module contains all of the

components necessary for the radio link, but is otherwise completely configurable. All of the transceiver configuration registers are available to optimize the RF link for the application with an external microprocessor through a three-wire interface. This allows the designer the ability to optimize the module for their specific needs. This includes controlling the radio to maximize battery life and optimize communication protocol. It also includes the ability to adjust the radio on-the-fly to improve the link quality through Received Signal Strength (RSSI) and Frequency Error Indicator (FEI) features.

The DP1203 modules can be used in any environment where wireless remote connection is an advantage. They are ideal for complex wireless networks involving high speed data rate applications. Examples include security systems, home and industrial automation, process, access and building controls, and home appliance interconnections.

For pricing info you can request a quote from their website.

For more information, contact:
Linx Technologies
Web: www.linxtechnologies.com

ULTRA LOW NOISE DUAL JFETS

Linear Integrated Systems announces the immediate availability of their LSK489 1.8 nV at 1 kHz low capacitance N-channel

monolithic dual JFET. This is part of a family of ultra low noise dual JFETs, specifically designed to provide users better-performing, wider bandwidths, and cheaper solutions for obtaining tighter IDSS (drain-source saturation current) matching and better thermal tracking than matching individual JFETs.

Available packaged in surface-mount and ROHS compliant versions, the LSK489 is an ideal improved functional replacement for JFETs that have similar noise characteristics but greater gate-to-drain capacitance.

The LSK489 SOT-23 and SOIC packages are also ideal for space-limited circuits in audio and



instrumentation applications.

Available LSK489 packages are: TO-71, SOT-23-6L, and SOIC-8L.

The most significant aspect of the LSK489 is how it combines a noise level nearly as low as the LSK389 while having much lower gate-to-drain capacitance — 4 pF versus 25 pF.

Like Linear System's LSK389, the LSK489 features a unique monolithic dual design construction of interleaving both JFETs on the same piece of silicon to provide excellent matching and thermal tracking, plus a low noise profile having nearly zero

popcorn noise.

Lead-free, ROHS compliant versions are available. Linear Integrated Systems' in-house fab and domestic factory stock offer short lead times.

Applications include: microphone amplifiers; phono preamplifiers; audio amplifiers and preamps; discrete low noise operational amplifiers; battery-operated audio preamps; audio mixer consoles; acoustic sensors; sonic imaging; instrumentation amplifiers; wideband differential amplifiers; high speed comparators; and impedance converters.

Price is US\$6.37 each (1,000 pcs TO-71).

For more information, contact:
Linear Integrated Systems
Web: www.linearsystems.com

D-AXE II DEVELOPMENT BOARD FOR THE PICAXE

Aztec MCU Prototyping now offers the D-Axe II development board intended primarily for use with PICAXE microcontrollers. Engineered in Canada and carrying their house brand – Omega MCU Systems (OMS) – this board builds on the success of its predecessor and

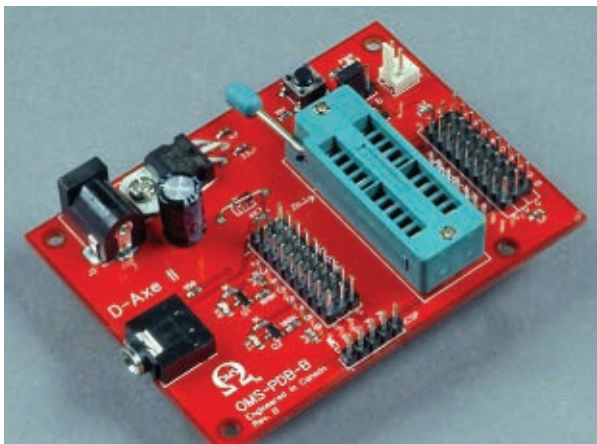

provides a highly versatile and modular platform from which to develop projects based on PICAXE eight-, 14-, and 20-pin microcontrollers. As with all of the OMS branded products, it is designed to speed up the building of prototypes and make the whole process more reliable and repeatable.

The D-Axe II is manufactured using SMD technology on high quality 1.6 mm thick double-sided FR4 fiberglass printed circuit boards with 1 oz copper traces for long life under hard use. All signals from the microcontroller are brought out to three-pin headers that include access to the power and ground. This allows the designer to simply plug in sensor and actuator modules (commonly known as 'bricks') to build prototypes in a matter of minutes.

These same headers allow the D-Axe II to also be connected to solderless breadboards, making it a versatile development platform. It has a 3.5 mm stereo phone jack for compatibility with existing AXE026 and AXE027 PICAXE programming cables, and onboard LEDs indicators to monitor programming and data traffic. An onboard power regulator capable of supplying up to 1A ensures that it can support a large array of modules.

For those situations where a hard reset is required to begin a new program load, the D-Axe II offers a simple pushbutton solution avoiding the traditional means of having to remove the power supply. A zero insertion force socket is used to keep chips in top shape while reducing the handling time. It is fully compatible with all current PICAXE programming software.

While the D-Axe II is primarily intended for use with a PICAXE, it also supports a host of small PIC microcontrollers via

a standard ICSP header.

Benefits offered by the D-Axe II help users get to writing and finishing code as quickly as possible by reducing build time, and increasing reliability and repeatability of the prototyping process. The D-Axe II is available for a limited time for US\$14.99.

For more information, contact:
Aztec MCU Prototyping
Web: www.aztecmcu.com

SINGLE RELAY BOARD

The new single relay board from Parallax can be used to turn lights, fans, and other devices on/off while keeping them isolated from a microcontroller. The single relay board allows users to control high power devices (up to 10A) via the onboard relay. Control of the relay is provided via a 1 x 3 header which is friendly to servo cables, and convenient to connect to many development boards. Price is US\$9.99.

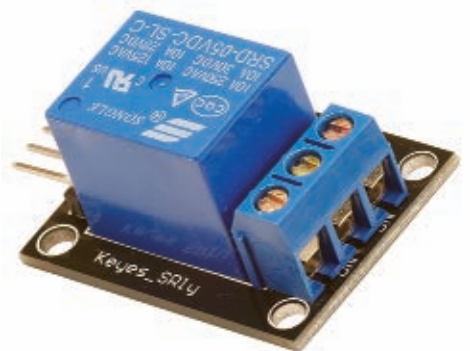

PRESSURE SENSOR MODULE

Parallax's new SCP1000 pressure sensor module is an absolute pressure sensor which can detect atmospheric pressure from 30-120

kPa. The pressure data is internally calibrated and temperature compensated. The SCP1000 also provides temperature data and has four measurement modes, as well as standby and power-down mode.



All that is required to obtain pressure data in kPa or temperature data in degrees Celsius is a single multiplication operation using constants. Communication is via an SPI bus which also provides additional control lines such as an interrupt line and trigger input. Price is US\$24.99.

PROPELLER MINI

Also new from Parallax is the Propeller Mini – a low cost solution for embedding a multi-core microcontroller system in hard-to-reach places or small-sized projects where a full-sized development board is not practical. The board is small in size and component count, while having the necessary features one would expect from a control board.



Users can solder the included header onto the Propeller Mini and be ready for breadboarding out of the bag. There is also the option of soldering a project's wire leads

directly to the through holes on the board to keep the control system for a project small. Users can solder sockets onto the Propeller Mini so it can plug into a proto board containing sensors and other components. Price is US\$24.99.

For more information, contact:
Parallax
Web: www.parallax.com

AC TEMPERATURE CONTROLLER

Oven Industries announces the new 5R1-1400 AC temperature controller with integrated



potentiometers, or via a PC through the TTL level UART communication port. This compact design (measuring 2-1/2 inches square) can deliver up to 15 amps of load current from a zero voltage switched low noise solid-state relay. Operator safety is achieved with 1 KV of AC line power isolation for the communication port and sensor input. Specifications are: input voltage 85 to 265 VAC 50/60 Hz; temperature resolution 0.1°C; and ambient temperature operation -20° to 70°C.

Features include:

- Universal AC input.
- Integrated potentiometers for set temp and PI control; PC programmable set temp and PID control.
- TTL level UART

- communication port.
- Set temp range determined by thermistor type.
- Open sensor protection.

Pricing is:
1 – \$114
2 – \$111
6 – \$108
10 – \$106

For more information, contact:
Oven Industries
Web: www.ovenind.com

SMALLEST HANDHELD MIXED-SIGNAL RPM O'SCOPE

Saelig Company, Inc., has introduced the Xprotolab Portable – a combination of three electronic instruments: a mixed signal oscilloscope (simultaneous sampling of two analog/eight-bit/200 kHz and eight digital/1 MHz signals); an arbitrary waveform generator; and a protocol sniffer.

As a mixed signal oscilloscope, it offers simultaneous 2 MSa/s



sampling of two analog and eight digital signals; as an arbitrary waveform generator, it provides advanced sweep options on all waveforms. As a protocol sniffer, it can decode SPI, I²C, and UART.

The Xprotolab Portable has an advanced triggering system: normal, single, auto, and free trigger modes; an adjustable trigger level; and the ability to view signals prior to the trigger. As a portable digital meter, Xprotolab Portable can show VDC, VPP, and Input Frequency to 12 MHz.

Lissajous figures, displaying V/I curves, or the phase difference between two waveforms is possible in XY mode. A built-in FFT spectrum analyzer offers different windowing options and selectable vertical log and IQ visualization. Channel math allows adding, multiplying, inverting, and averaging input signals.

Automatic waveform measurements and waveform references are offered too, with horizontal and vertical cursors. The waveform generator and the oscilloscope can run simultaneously, since the waveform generator runs in the background.

Based on an Atmel ATXMEGA32A4U microprocessor, the Xprotolab Portable can connect to a PC's USB port for charging the built-in 600 mAh battery, or for external control or screen dumps. The built-in graphic 1.3" OLED shows waveforms on its 128x64 pixel display. The Xprotolab Portable weighs less than 60 g and is a compact 3.13" x 1.83" x 0.7".

An auto setup feature sets the optimum gain and time base for signals on CH1 and CH2. Edge, window, and slope triggering is available, as well as trigger hold which enables a wait-time before detecting the next trigger.

The Xprotolab Portable continuously samples to a circular buffer, giving the ability to show samples before or after the trigger. Any analog channel, digital channel, or external signal can be used as the trigger source.

The Xprotolab Portable is available for US\$98.

For more information, contact:

Saelig

Web: www.saelig.com

Dimension Engineering

Sabertooth 2x60

Dual 60A Continuous Brushed Motor Controller

Specifications:

- 60A Continuous, 120A peak current
- 6V - 33.8V input voltage range (8s lipo max)
- Analog, RC (PWM), and Serial Interface
- Overcurrent, overvoltage, undervoltage, and overheat protection built in
- Fan cooling keeps the controller cool
- Heavy duty terminals take up to 2 gauge wire
- 1 year warranty on every Sabertooth
- DEScribe Software Suite Compatible

ONLY \$189.99

- www.dimensionengineering.com/Sabertooth2x60.htm - 899 Moe Dr. #21 Akron, OH 44310 - 330-634-1430 -



EARN MORE MONEY Get your dream job!

**Make up to \$100 an hour
and more as an FCC
Licensed Technician!**

**Get your "FCC Commercial Radio License" with
our proven Home-Study Course!**

- No costly school. No classes to attend.
- Learn at home. Low cost!
- No experience needed!
- **MONEY BACK GUARANTEE:** You get your FCC License or money refunded!



Turn your interest in electronics into a high paying career in Communications, Radio-TV, Avionics, Marine, Radar, Safety, Municipal and more... even start your own business!

Call for FREE info: 800-932-4268

Or, email us: info@LicenseTraining.com ext. 109

www.LicenseTraining.com

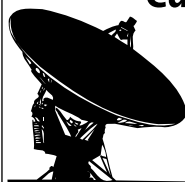

COMMAND PRODUCTIONS FCC License Training
Industrial Center, 480 Gate Five Rd., PO Box 3000, Sausalito, CA 94966-3000

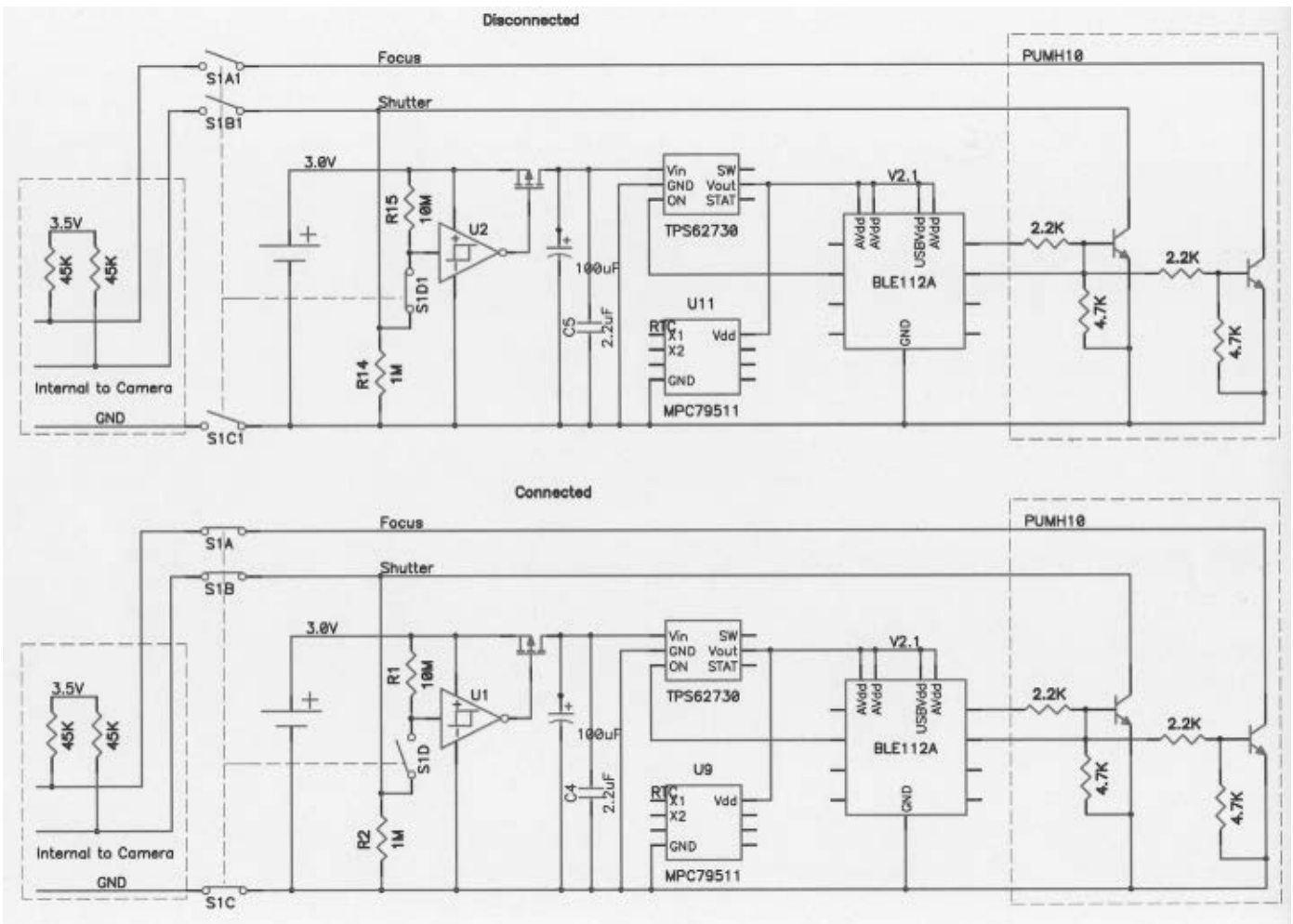

It is a boost regulator, generating 3.3V from a 3V battery. However, I found a few errors in his design/documentation.

1. The buck regulator is called TPS72630 in the text and in the schematic, and does not exist. He first mentions the TPS62730 correctly, so I assume it is a simple transposition.

2. The PUMH10 is misrepresented in the schematic as having FETs, rather than the NPN bipolar devices mentioned in the text and parts list. The ports of the BLE112A have enough drive to easily pull the camera inputs low, so the buffers could be eliminated (though don't forget to change the firmware). Unfortunately, the BLE module's ports are not truly open-drain. Because of the uC port's ESD diodes, the outputs

should not be pulled beyond 0.4 volts of the supply, preventing a direct connection to the camera without buffers.

3. The 3024 coin battery is specified at 3.0 volts, not 3.6 as in the text and schematic. A fresh one may read 3.25 with a Hi-Z meter, but will quickly drop down with a load applied.

4. The camera detect power-on circuitry doesn't fit the text description regarding the resistors connected to the input of the Schmitt inverter. I re-arranged and merged the schematics to get a clearer understanding of the connectivity. As drawn, the detect node will ALWAYS be low — 0.27 volts. As redrawn (and shown above) as I think was meant — with the 1M pulldown connected to shutter rather than detect — the

circuit is functional. Note there is a 1M + 45K load on the camera battery which causes a continuous 3.2 μ A drain. When disconnected, there is an 11M load on the coin cell as well. (Every nanoamp counts.)

5. I would tend to leave the camera plug in place for long periods, since the connector is not very sturdy and I don't want to cycle it excessively. I would disconnect the dongle using the 2.5 mm plug. With the plug dangling, it may make contact with something metallic and fire the trigger — or at least cause camera battery discharge. I would use a female connector on the camera side and a male on a cable from the controller.

Steve McChrystal

Continued on page 48

Recycling & Remarketing High Technology

WEIRDSTUFF[®] WAREHOUSE

Software, Computers, Electronics, Equipment, Doohickies

WE BUY/SELL EXCESS & OBSOLETE INVENTORIES
FREE COMPUTER AND ELECTRONIC RECYCLING
GIANT 10,000 SQ. FT. AS-IS SECTION

**384 W. Caribbean Dr.
Sunnyvale, CA 94089**
Mon-Sat: 9:30-6:00 Sun: 11:00-5:00
(408)743-5650 Store x324
WWW.WEIRDSTUFF.COM

www.Primecell.com

Battery rebuilding service

Dead Batteries? Don't toss them. Send them to us - our rebuilds are better than original specifications.

Tools

- Hilti Skill
- Milwaukee
- Panasonic
- B&D DeWalt
- Makita All
- 2-36 Volts

Electronics

- Bar Code Scanners
- Surveying Printers
- Laptops
- Photography

Radios

- APELCO
- UNIDEN
- G.E. ICOM
- KENWOOD
- MOTOROLA
- MIDLAND
- MAXON
- YAESU
- ALINCO

Visit www.primecell.com for important details
24 Hr Secure recorder tel-fax (814) 623 7000
Quotes email: info@primecell.com
Cunard Assoc. Inc. 9343 US RT 220 Bedford PA 15522

d6 LABS



RFM22B
\$6.95 ea 100mW Transceiver

RFM50B
\$9.90 ea 100mW Transceiver w/8051 uC

www.d6labs.com

NKC electronics

MDE8051 Trainer by Digilent

NKCElectronics.com/MDE8051

Includes the MDE8051 training board, power supply, serial cable

Purchase Orders are accepted from Educational Institutions, US Government and Research Centers

ROBOT POWER Extreme Motor Speed Control!

MegaMoto - Motor Control for Arduino™

- 6V-28V - 13A / 30A peak
- Single H-bridge or dual half
- Current and Temp protected
- Jumper select Enable and PWM pins
- Up to three units stack on one Uno/Duemilanove

Dalf - \$250

- Closed-loop control of two axes
- Windows GUI for all features
- Full PID position/velocity loop
- Trapezoidal path generator
- Giant Servo Mode!
- www.embeddedelectronics.net

>> Also H-bridges, gearmotors, plans, schematics <<

www.robotpower.com
Phone: 253-843-2504 • sales@robotpower.com

QKITS.COM

12V USB Relay cards are based on the Arduino physical computing Controllers.

Program them as stand-alone using open source Arduino IDE.

KTA-223 has 4 optically isolated digital inputs, 3 analog inputs, 8 relay outputs.

KTA-225 has 8 analog inputs, 8 relay outputs.

Call 1 888 464 5487 to order!

In the Nuts & Volts Webstore NOW!

NUTS AND VOLTS

Introducing the **chipKIT Combo**

Getting Started with **chipKIT™**

chipKIT™ Uno32
Designed for the Arduino Community

chipKIT Uno32 Component Pack

Chuck Hellebuyck

Only \$58.95

Combo includes:
Getting Started with chipKIT book
chipKIT UNO32 Module
USB Cable with mini B connector
14 project components

<http://store.nutsvolts.com>

In the Nuts & Volts Webstore NOW!

NUTS AND VOLTS

NV BOOK SPECIALS

Free STD Shipping!

PRACTICAL ELECTRONICS FOR INVENTORS

Raspberry two book combo

Programming the Raspberry Pi
Getting Started with Python

Raspberry Pi User Guide

For more specials and subscriber discounts please visit:
<http://store.nutsvolts.com>
Offer Ends 9/31/13

SLIDE MOUNT for MOBILE RADIOS
UNIVERSAL: FITS MOST 2 WAYS

Model ET-850 Universal Slide Mount. Standard mounting platform, specify radio make/model. Ends blind fumbling to release hidden fasteners. Easily transfer radios from vehicle to vehicle. Also use in the office, job trailer, marine too. Black powder coat finish. Volume prices.

(Ask about our maximum security Locking Radio Cage™ Mount)



E TIP, Inc., North Aurora, IL 60542 USA
(800) 530-5064 FAX (830) 801-9569
www.etipinc.com | sales@etipinc.com

E TIP is a Veteran Owned Small Business

Small Mechanical Components for **ROBOTICS**

800-819-8900



SDPSI Visit sdp-si.com and Buy Online Today.

BUILD A HEADSET AMPLIFIER



By Ronald W. Anderson
ronwande@bellsouth.net

Go to www.nutsvolts.com/index.php?/magazine/article/september2013_Anderson for any additional files and/or downloads associated with this article. You can also discuss this topic at <http://forum.nutsvolts.com>.

The August issue of N&V featured my construction article "Build a Low Cost, High Performance 12 Watt Amplifier for Eight Ohm Speakers."

That article erroneously had the wrong photo at the top. The photo shown here should have been the photo. (This correct photo actually did appear later in the article.)



The incorrect photo at the top of the amplifier article is the one at the top of this present article which describes the construction of a headset amplifier.

The two amplifiers are quite similar, using a very conventional three-stage design called the Lin Architecture named after Hung C. "Jimmy" Lin — an electrical engineer who invented components that are commonly used in solid-state amplifiers, audio speakers, microphones, and headphones. There will be an additional article next month that describes the theory behind the headset amplifier, but most of that discussion will apply to the power amplifier presented last month, as well.

This project is a headset amplifier that can be driven by a CD or MP3 player, and can drive a good high fidelity headset. My headset has an impedance of about 32 ohms; some range as high as 600 ohms. This circuit will drive any headset in that range and beyond. Some high-end audio folks consider integrated circuit operational amplifiers not to be very good ... something about too many transistors in the signal path. This circuit uses all discrete components — no more and no less than required to provide wide bandwidth and low distortion. I suppose someone will argue that \$2 worth of transistors can't possibly sound as good as a \$10 operational amplifier.



I am a retired graduate electrical engineer who has been interested in audio since high school. A few years ago, I got interested in solid-state amplifiers and bought some books on the subject. Since then, I've built a number of amplifiers with superior specifications and very low cost.

This simple amplifier has very low distortion and flat frequency response well beyond the audio frequency range. Cost of parts for one channel including the power supply will be about \$30; a second channel will only add about another \$15.

If you live in a large metropolitan area, you can find all the parts at a local distributor. If not, I've listed a number of sources for parts here in the article.

This project is rather forgiving of beginner's errors. The design is simple and straightforward, but its performance is equal to or better than the best commercially-available amplifiers in terms of low distortion and noise, wide frequency response, and high damping factor. I also added tone control.

ERRORS BUILDING SOLID-STATE CIRCUITS

A number of experimenters have little success with constructing solid-state amplifiers. The reason is that a short circuit or misconnection can result in instant destruction of semiconductor devices. Miswiring a vacuum tube will sometimes have no ill effect at all and sometimes make the plate glow red hot. If you are watching, you can cut the power and find the error.

A wiring error in a solid-state amplifier can result in instant destruction. If you build this solid-state amplifier carefully, however, it will be very reliable. When testing the solid-state device using a probe for a voltmeter or oscilloscope, a slip can cause a disaster, so be careful.

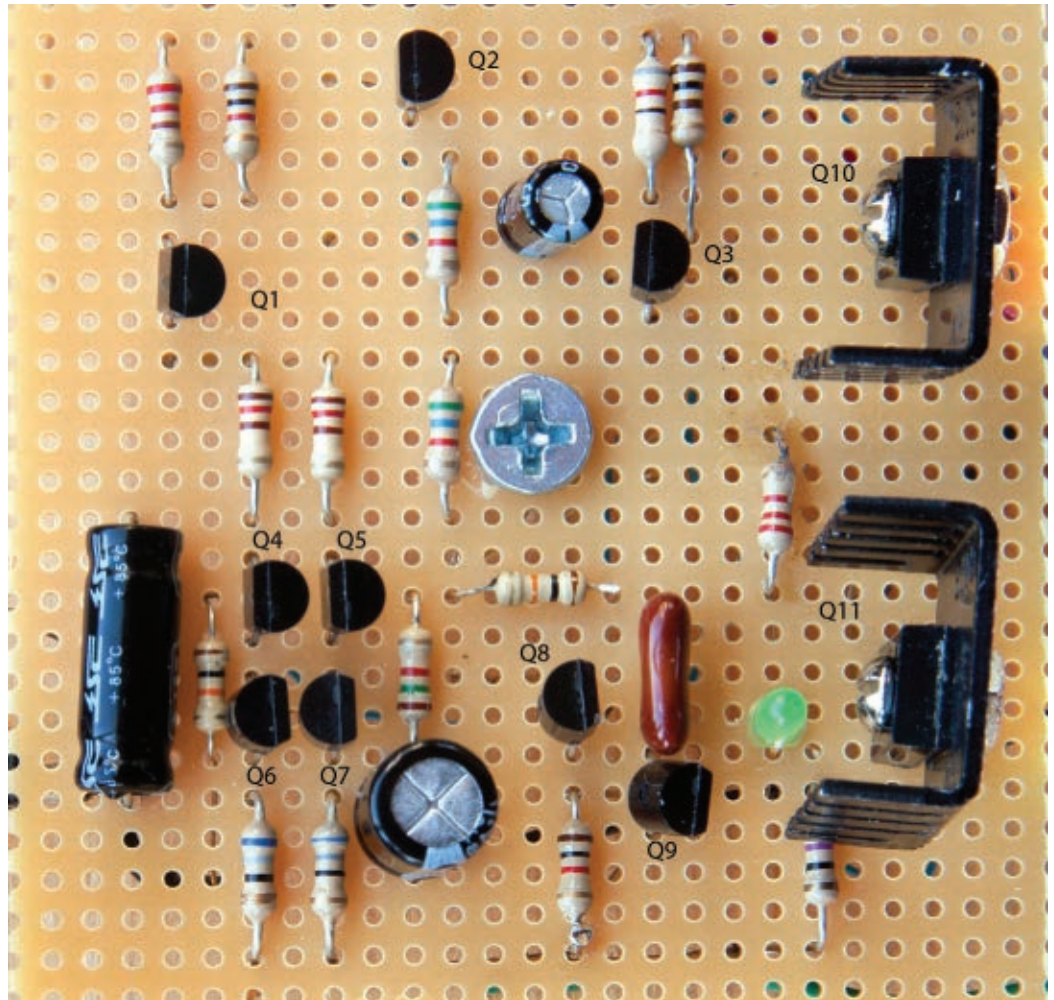

■ FIGURE 1. One channel assembled on perfboard.

you do slip, the transistors used here are quite inexpensive, so no great harm will be done.

The most common error (I've done it myself more than once) is to wire a transistor wrong. Small signal transistors of the plastic case TO-92 type are usually wired with the leads down and the flat of the case facing you; the leads are from left to right, EBC. That is: emitter, base, collector. The 2N5551 and 2N5401 used in this project are wired in that order.

The output transistors are TO-126 style. With leads downward and the label towards you, the leads are from left to right ECB (Emitter, Collector, Base). These TO-126 transistors will have TO-220 style heatsinks attached (see **Figure 1**). Get the type with a hole for mounting the transistor with a screw and nut. Be sure these heatsinks don't touch each other since they have positive and negative supply voltages on them. A dab of heatsink compound between the transistor and the heatsink is good, but probably not necessary at this point.

Another less common error in wiring is to reverse the

power supply voltages. Referring again to **Figure 1**, the positive supply is at the top and negative is at the bottom.

POWER SUPPLY CONSIDERATIONS

Regulated power supplies are a totally unnecessary complication in this project. A well designed amplifier done with power supply rejection in mind doesn't care about precise power supply voltages. Power supply rejection (the ability of the amplifier to ignore ripple voltage and changes in supply voltages) is excellent in these amplifiers. I tend to use perfboard for prototypes (also referred to as Vector board for the name of the manufacturer). The holes are at 0.1" centers which is convenient for placing parts.

For this headset amplifier's power supply, I suggest an

18 volt center-tapped transformer. The rectifiers (1N4001s) are very inexpensive and widely available. The filter capacitors can be found at several surplus places.

GETTING HOOKED UP

Output voltage will be about ± 12 volts – perhaps a little higher with no load. Connect the ground ends of the two filter capacitors very solidly and run a short bus off of them. Connect the center tap of the transformer here. This will be the "quality ground" for the amplifier.

The amplifier ground will connect to this point using ordinary hookup wire. The headset ground return should be to this point, as well. Headset wiring doesn't need to be anything special. Ordinary hookup wire will be fine. Of course, you will want to connect a headset jack to the output.

■ **FIGURE 2.**
Amplifier schematic.

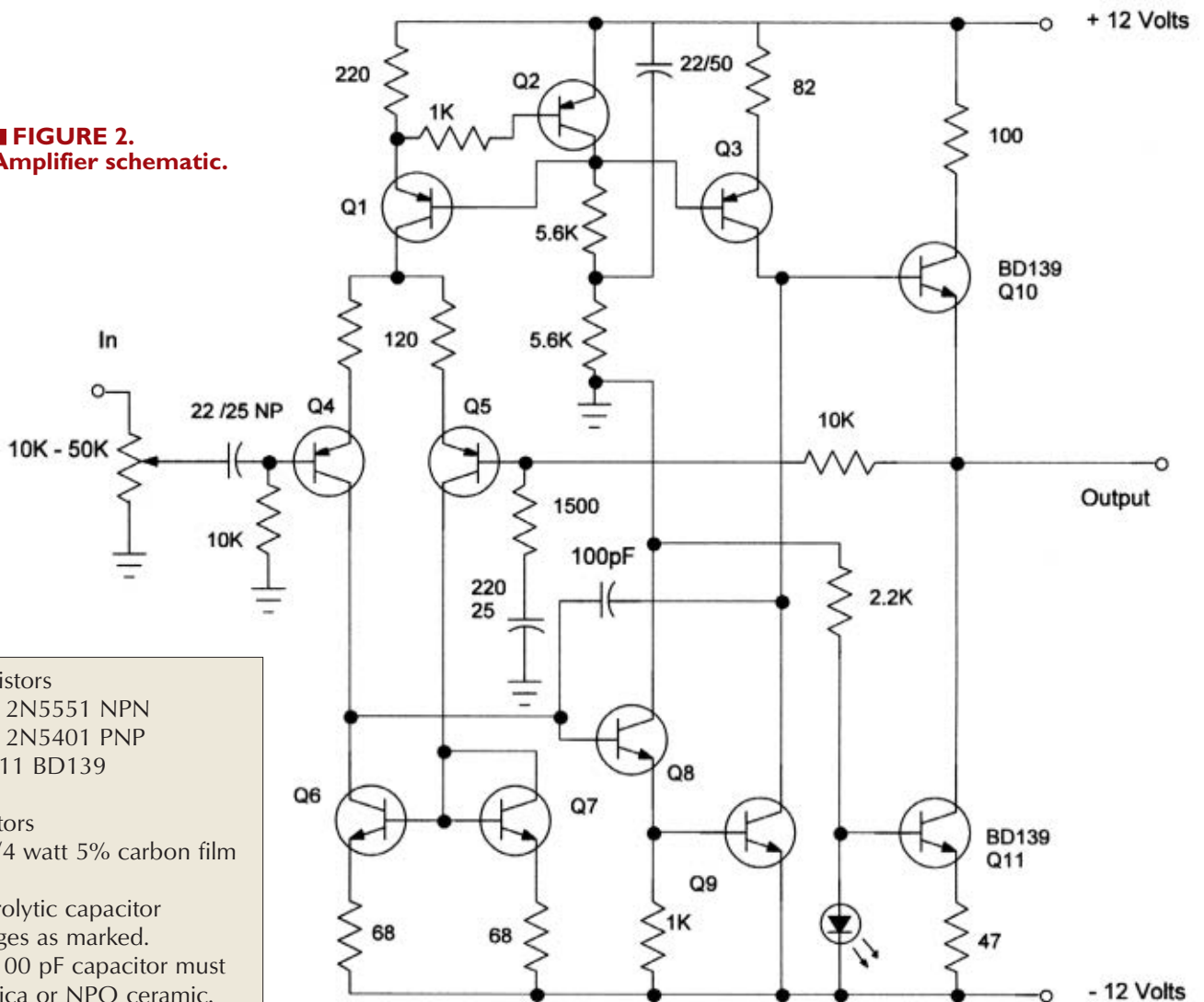

Transistors
Q1-5 2N5551 NPN
Q6-9 2N5401 PNP
Q10-11 BD139

Resistors
All 1/4 watt 5% carbon film

Electrolytic capacitor
voltages as marked.
The 100 pF capacitor must
be mica or NPO ceramic.

CONSTRUCTING THE AMPLIFIER

Small transistors in **Figure 1** with the flat to the left are PNP 2N5401; the ones with the flat facing right are NPN 2N5551. These are available at more than one of the sources listed here. I recommend purchasing a supply of each of these types.

The voltage rating is much higher than needed here, but they can be used in other higher power amplifier designs, as well. I saw the NPN for about four cents each in 100 lots. The PNP was more like five cents.

Shorting the output to ground won't blow up the amplifier. If the amplifier does suddenly output the full power supply voltage, it won't (in general) wreck a pair of headphones, but don't poke or probe at the amplifier with the headphones connected anyway. That is simply asking for trouble.

The overall amplifier is DC coupled. For safety, since a device connected to the input might have a DC voltage on its output, a coupling capacitor is used. One 22 μF non-polar capacitor or a pair of regular polarized capacitors back-to-back can be used (also 22 μF).

This input coupling capacitor (or capacitors) protect the amplifier in case a substantial voltage is accidentally attached to the input. This makes the lower 3 DB response frequency about 3 Hz. Since we can't hear much below 20 Hz, this is more than adequate.

Construction is easy on a piece of perfboard. Place the parts as they appear in **Figure 2** for easy checking of the wiring when you are done. I generally use component leads to make interconnections on the back of the board and wire-wrap wire for connections where the wires are

not long enough, or wires have to cross each other. I always solder them. The wire is thin and has thin insulation, making it easier to work on the board. However, if you nick the conductor when stripping the wire, it can break easily so be careful.

Observe the proper polarity of the LED. The one I've used has one longer lead which is the positive one, i.e., the anode. You might want to test an LED and the 2.2K resistor connected to a 12 volt power supply to be sure you have the right polarity.

Check the voltage across the LED. It needs to be about 2.1 volts. Different colored LEDs have different forward voltages, so you might have to try a few different types. These devices make very good voltage references. You can place one on the front panel of a box if you decide to build two channels and package them.

TESTING

Don't connect the headset yet. Solid-state amplifiers are comfortable with no load. DON'T just connect and turn on the power when you are done. With a multimeter, check the resistance from each power supply lead to ground one at a time. Resistance less than 1K ohm or so indicates a problem.

Trace your wiring carefully to catch omitted wires, untrimmed resistor or capacitor leads, and/or accidental solder bridges. If the board is laying on your workbench, be sure there are no scraps of resistor leads or tools under the board. Short circuits need to be avoided if the circuit is to have a chance to work. I've had a circuit blow up due to a resistor lead on the bench.

When you apply power, note that the LED lights. If the output transistors get more than just slightly warm or if the 100 ohm resistor in series with the collector of the

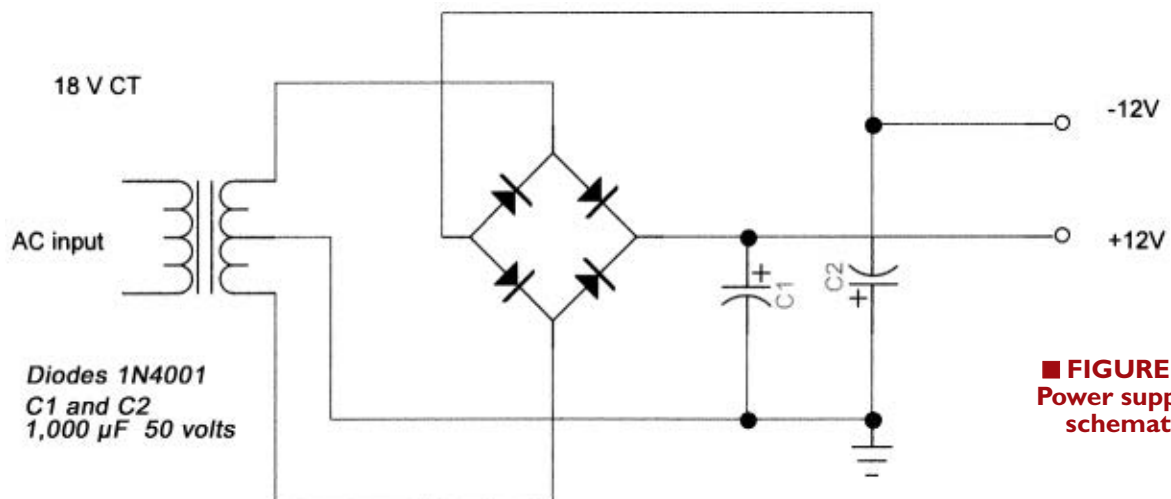

■ **FIGURE 3.**
Power supply
schematic.

output transistor gets hot, you've done something wrong.

Assuming no smoke, measure the output voltage to ground. If it is not within 20 or 30 millivolts, there is a problem. My breadboard circuit measures close to 0 mV. If your voltmeter doesn't go down that far, set it to the 20 volt or more range, then connect it between output and ground. If the needle doesn't move, switch to successively lower ranges. On a one volt range, you might see the

needle move a little.

Assuming low voltage, connect an audio source to the input. A CD or MP3 player is convenient. If you have a scope, connect it to the output and adjust the volume control for a few volts peak-to-peak output and note that the peaks are not clipped.

HEADSETS

Headsets come in a variety of impedances and sensitivities. A search on the Internet found headsets with impedances from 600 ohms all the way down to 24 ohms.

This amplifier is current-limited at the output. It should not damage any headset due to high signal levels and the output is protected against a short circuit. High-end headset users worry a bit about the damping factor. (In an audio system, the damping factor gives the ratio of the rated impedance of the loudspeaker to the source impedance.)

The amplifier has very low output impedance and provides a high damping factor for any headset. If you have a low impedance set, be aware that the volume control must be turned to a low level. I've left the gain

QTY	POSSIBLE SOURCE
Power Supply	
1 Transformer 18 volts CT at one amp	Marlin P. Jones
4 1N4001 rectifier diodes	
2 1,000 μ F 25 volts or more	
Amplifier	
Resistors all 1/4 watt 5% carbon film	
1 47	
2 68	
1 82	
1 100	
2 120	
1 220	
2 1K	
1 1500	
1 2200	
2 5600	
2 10K	
Transistors	
5 2N5401	Tayda
4 2N5551	Tayda
2 BD139	BG Micro
Capacitors, electrolytic	
1 22/50	
2 22 at 25 or one 22 at 25 non-polar	
1 220 at 25	
Capacitor, ceramic NPO or silver mica	
1 100 pF at 25 or more	
Miscellaneous	
1 Perfboard 0.1 in hole centers	Jameco
2 TO-220 heatsinks	
1 Dual ganged potentiometer, 50K linear (for two channels)	Tayda
Stereo headphone jack, your choice to match your phones	
Power switch	
Fuse 1A	
Project box	Jameco
Line cord	
2 RCA jacks for input	

PARTS LIST

SUPPLIER DETAILS

All Electronics — Van Nuys, CA. Has resistor and capacitor kits with a number of values.

Allied Electronics has a good selection of transformers.

B&D Enterprises has hard-to-find semiconductors.

BG Micro is in Garland, TX. They have surplus capacitors, diodes, etc. The BD139s are available at BG Micro for about 40 cents each.

Digi-Key is in Thief River Falls, MN. They seem to have everything.

Jameco, in the San Jose, CA area, tends to cater to hobbyists. Vector board is available at Jameco.

Marlin P. Jones in Florida has a good selection of transformers. They have one rated at one amp for \$4.95. Your local RadioShack may have one for about the same price if you include shipping charges.

Mouser is more of an industrial supplier but has a lot of good stuff.

Tayda has the 2N5551 and 2N5401 for very low prices. Note this supplier is in Bangkok, Thailand but the prices are very low and shipping is not costly if you are not in a hurry. I receive orders from them in less than 10 days. They have a limited selection of items.

Parts Suppliers:

All Electronics	www.allelectronics.com
Allied Electronics	www.alliedelec.com
B&D Enterprises	www.bdent.com
BG Micro	www.bgmicro.com
Digi-Key	www.digikey.com
Jameco	www.jameco.com
Marlin P Jones	www.mpja.com
Mouser	www.mouser.com
Tayda Electronics	www.taydaelectronics.com

high to accommodate high impedance headsets. Thanks to a friend, I've tested the amplifier with 32 ohm, 60 ohm, and 300 ohm headsets.

This design is capable of considerable power in terms of what a headset needs. It was made this way so it can accommodate a wide variety of headset impedances. Set the volume at a reasonable level. Audio is not much of a hobby if you damage your hearing! If you have done everything correctly, you should hear clean audio. The amplifier clips at an output of around 35 mA peak. This is no problem in terms of the signal required to drive a headset to high volume. Now, all you have to do is build a second channel, and mount the amplifiers and power supply in a suitable project box. Once securely mounted, it will be very reliable.

Measured distortion at three volts out at 20 Hz on up to about 1 kHz is 0.0012%. It changes very little from no load to a couple hundred ohms. I have a Hewlett-Packard 339A distortion test set that includes a very low distortion signal generator and the analyzer. It measures total harmonic distortion plus noise (THD+N). The 339A measures 0.0012% when the signal generator output is connected directly to the analyzer input; that is, the reading is the same with the amplifier as it is without it.

Distortion at 20 kHz measures 0.0021% with a 1K load, rising to about 0.008% with a 100 ohm load. Distortion will depend on the impedance of your headset and the sensitivity. More sensitive headsets require less input power and will have less distortion.

Readings are obviously very near the limit of the capability of the analyzer. The normal listening level will be about 0.3 to one volt AC at the headset. Response is down 3 DB at around 600 kHz. Response must go far beyond audio frequencies in order to insure that there is enough negative feedback at 20 kHz to reduce the distortion to a low level. (This topic deserves an article by itself.)

I think it is fairly safe to say that

distortion will be less than 0.01% over the audio frequency range at normal to loud listening levels with nearly any reasonable headset. Distortion depends somewhat on construction techniques and on individual transistor characteristics.

Remember next month, we will discuss the theory of this headset amplifier design. Happy listening! **NV**



\$51 For 3 PCBs
FREE Layout Software!
FREE Schematic Software!

- 01 DOWNLOAD our free CAD software
- 02 DESIGN your two or four layer PC board
- 03 SEND us your design with just a click
- 04 RECEIVE top quality boards in just days

expresspcb.com

DETECTING SOUNDS WITH THE SONIC SENSOR

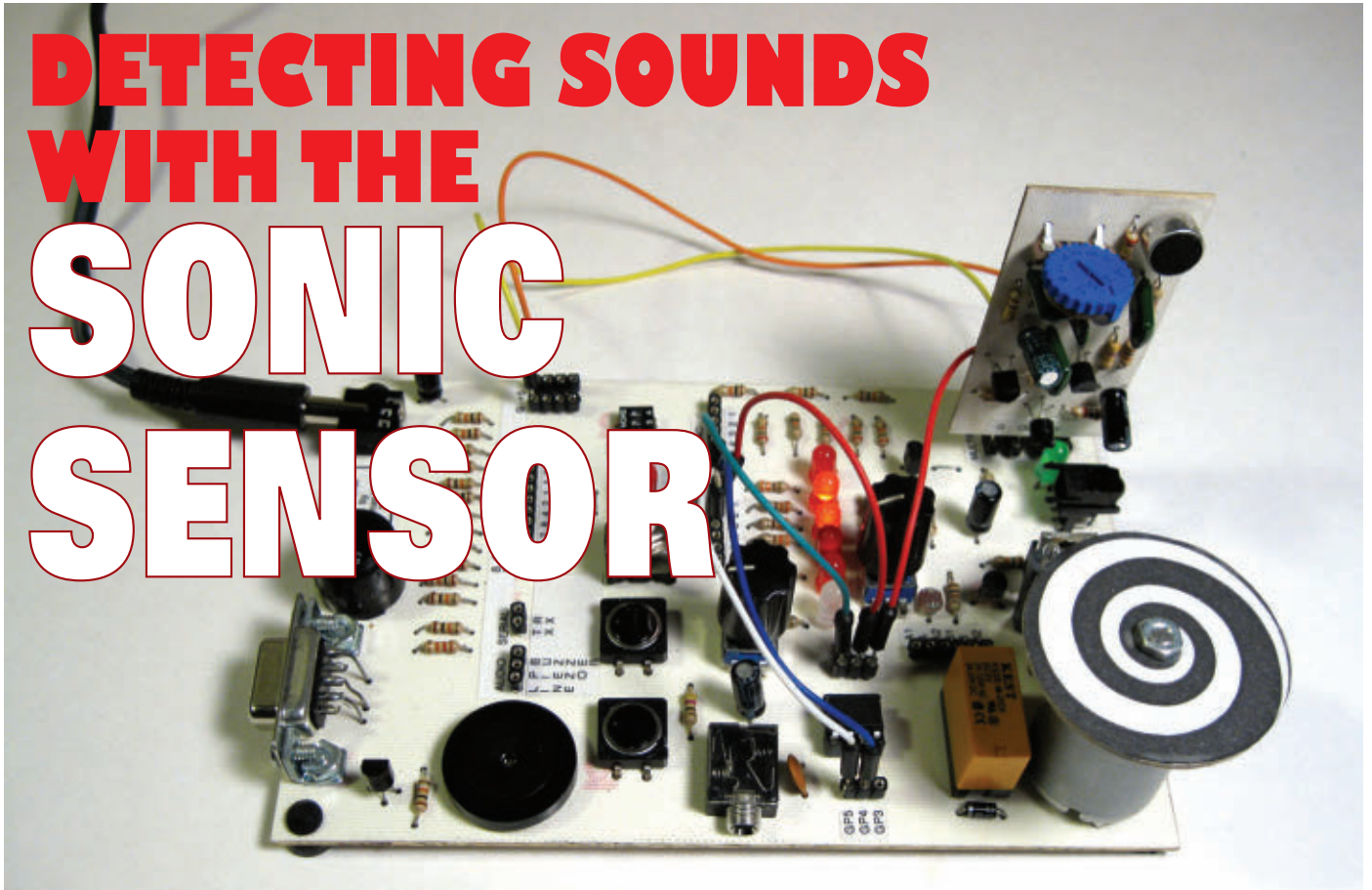

By Thomas Henry
studs.kreitzer@gmail.com

Go to www.nutsvolts.com/index.php?/magazine/article/september2013_Henry for any additional files and/or downloads associated with this article. You can also discuss this topic at <http://forum.nutsvolts.com>.

If your pastimes include fiddling with microcontrollers, then you've probably already experimented with sensing light, temperature, humidity, infrared, touch capacitance, and so forth. Have you ever considered brewing up a circuit that will respond to sound?

This is a fun project with lots of unusual applications in the areas of home security and remote control. For example, the module to be described here could be used to detect breaking glass, thunder claps, barking dogs, or a baby crying. It can even detect explosions or gunshots should you dwell in that sort of environment.

The application I originally had in mind is a little more down to earth: a circuit that responds intelligently to handclaps and then controls outboard equipment.

Called the Sonic Sensor, it can directly drive digital

circuits such as CMOS counters or common timers for more advanced responses. Even better is hooking it up to a PIC, Arduino, or other processor, and letting the software work some additional magic.

To keep things concrete for the moment, let's suppose our task is simply to sense handclaps and then control various appliances when detected. You're probably already smirking, thinking of cheesy commercial novelties you've seen before. (Heck, I even ran across such a unit in the close-out bin of a RadioShack some 25 years ago.)



More recently, a number of reviewers have complained about the usability of clapping switches on Amazon.

The Sonic Sensor deals with the reliability issue nicely, and pairing the device with a microcontroller opens up the possibility of even more exotic options.

Theoretically, detecting handclaps should be easy. The amplitude envelope of a microphone is preamplified, rectified, and filtered, and then a comparator trips whenever a certain threshold is reached. Unfortunately, various practicalities make this undertaking surprisingly difficult, and the tradeoffs must be carefully balanced to arrive at a truly useful gizmo. In fact, I went through three distinct revisions and topologies before arriving at a trustworthy circuit! As a first step, let's see what the design goals are.

The Sonic Sensor should:

- Have adjustable sensitivity.
- Be fast but not prone to ripple in the filtered envelope.
- Provide a gate output when sound is detected.
- Operate on +5V for easy interfacing with microcontrollers.
- Be small enough to build as a plug-in unit for use with breadboards, yet be as simple and inexpensive as possible.

It took some doing, but these goals were nicely met. Shall we see how it works?

■ FIGURE 1.

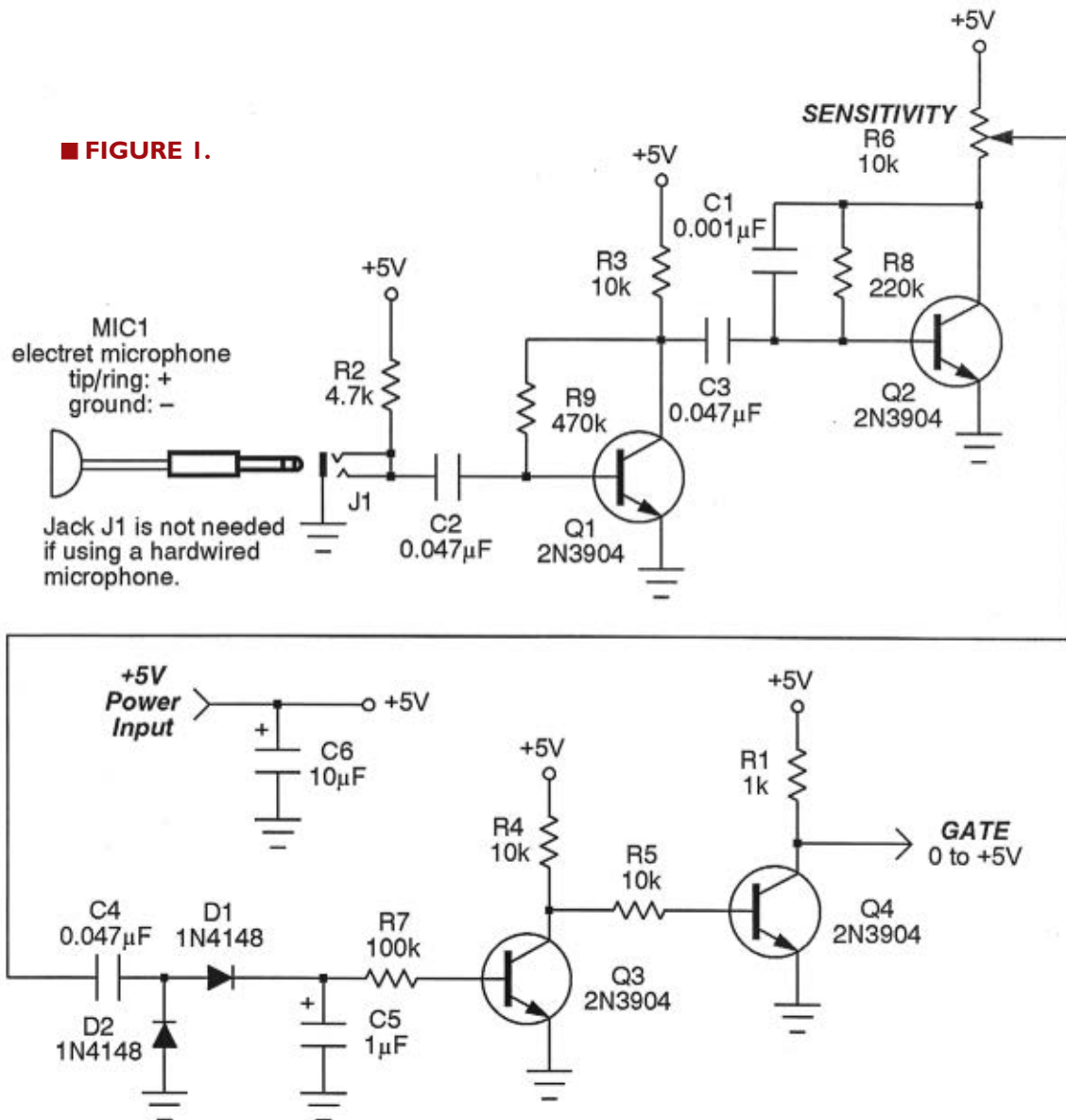

Theory of Operation

Refer to **Figure 1** which shows the schematic. After a couple false starts, I elected to go with a discrete design which keeps the unit small, but more importantly, is easy to run on a unipolar power supply. An electret microphone is used as the sensor. These are active devices, with R2 providing the bias from the power supply.

Notice, however, that capacitor C2 blocks the bias voltage from later stages, while allowing the AC audio signal to pass. I picked up the parts for this project as surplus from All Electronics (www.allelectronics.com), including the electret microphone. Unbelievably, that set me back a whopping fifty cents and yet works extremely well. If you'd like, you could use an external microphone on a cable with plug, but I went with a soldered-in unit.

The audio signal appearing on the far side of C2 is quite miniscule at this point – less than five millivolts – so we'll have to preamplify it. Q1 and associated components carry out that job. The larger signal is then chained to a second preamplification stage configured around Q2.

Both of these stages thus far (Q1 and Q2) are extremely primitive, but why open a can of beans with a stick of dynamite? They get the job done, and niceties such as temperature compensation, flat response, low noise, and the like simply aren't important

when detecting handclaps.

Since the gain is moderately high in both, spurious oscillation is always a possibility. So, feedback capacitor C1 is plopped in place to damp it out if it tries to rear its ugly head. The total gain is around 1,200. Thus, a weak microphone signal has now become a much beefier three volts or so.

Sensitivity is dialed in by means of potentiometer R6. The tamed signal is passed on to the simple half-wave rectifier. D2 dumps the negative half of the waveform to ground, while D1 passes the positive portion on to C5. If you'd like, you can think of this capacitor as a low-pass filter. Or, if you prefer, as a peak detector. Either way, a DC voltage proportional to the microphone's amplitude envelope is routed to Q3 which more or less switches on for larger signals.

The transistor may not saturate completely and also inverts the DC voltage, so we'll send its output to Q4 which is a true switch now. The output becomes a solid gate, swinging smartly from 0V to +5V whenever the amplitude set by R6 exceeds a certain level.

You might think this is all too ingenuous to get the job done, but keep in mind we're just trying to sense bursts of noise and simply want a digital output: on or off. For these reasons, there is no need to call out the heavy artillery. All of the usual headaches like response time versus ripple, resolution, and the like are of no real concern.

Build It in an Evening

The Sonic Sensor is a snap to build and a nice one-night project for DIYers at any level of experience. None of the parts are hard to find, nor are there any special construction concerns. It could easily be assembled on a

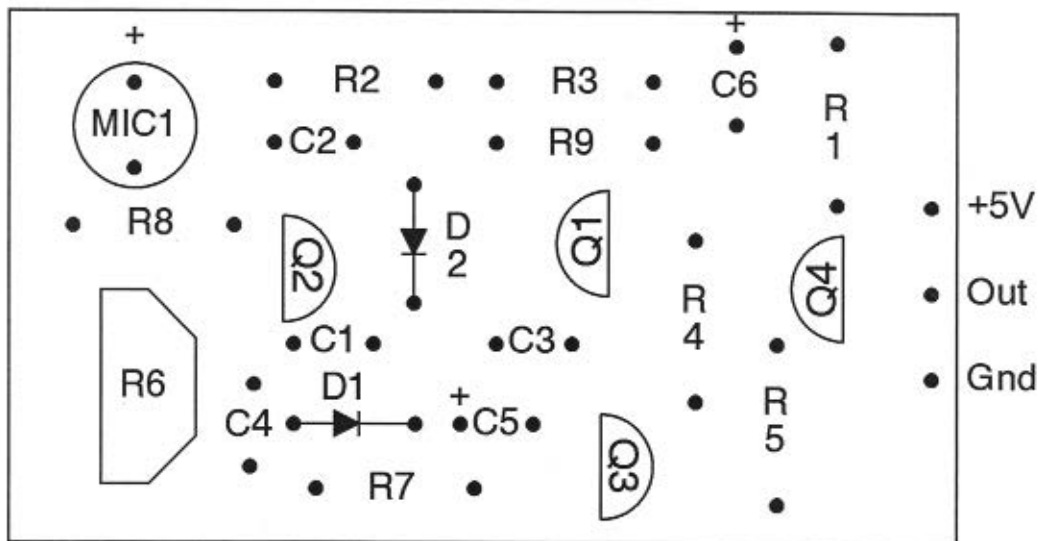
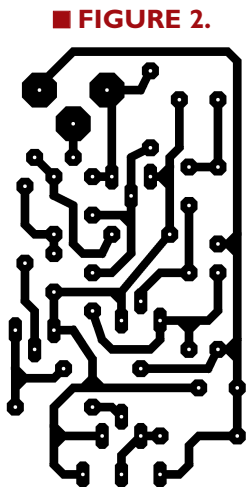

(not to scale)

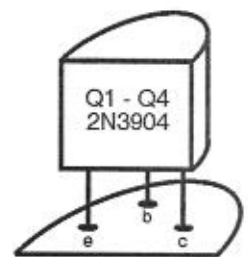

FIGURE 3.

All fixed resistors are 1/4 watt, 5% values.

Resistors

R1	1K
R2	4.7K
R3–R5	10K
R6	10K trimmer
R7	100K
R8	220K
R9	470K

Capacitors are 10V or better.

C1	0.001 μ F mylar
C2–C4	0.047 μ F mylar
C5	1 μ F electrolytic
C6	10 μ F electrolytic

Semiconductors

D1, D2	1N4148 diode
Q1–Q4	2N3904 NPN transistor

Other components

MIC1	Electret microphone
------	---------------------

Miscellaneous: Circuit board, solder, wire, header pins, optional jack, etc.

PARTS LIST

piece of stripboard, but I prefer to use homemade printed circuit boards (PCBs). Since this affair weighs in at a diminutive 1-1/4 by 2-1/2 inches, that undertaking could even be tackled with nothing more than a small bowl of etching solution.

I got the job done (from artwork design to an etched and drilled board) in a couple hours just working with a slapdash system out of my kitchen. **Figure 2** shows the PCB artwork I used, while the parts placement guide appears in **Figure 3**. **Figure 4** is a photograph of how my unit ended up.

Here are a few notes of interest to guide you along.

As mentioned earlier, I went with a soldered-in microphone; you'll spot it in the upper right-hand corner. Next to it is a thumbwheel type trimmer potentiometer (R6). Any type of pot is useable here, though. If you'd prefer to build the thing in a small box with a panel mount control, go for it.

I wanted to be able to use the Sonic Sensor on a breadboard and so utilized pins for ground, +5V, and output spaced in increments of 0.100 inches. I even went one step further and spread them out every other pin so the device would fit into the multiples of the DIY PIC Trainer I wrote about in the February 2013 issue of *Nuts & Volts*



■ **FIGURE 4.**

(pp. 32-37). You'll see it installed on the Trainer in **Figure 5**. A plug-in module sure makes life sweet for some rapid deployment of ideas!

Using the Sonic Sensor

I suppose you could connect the Sonic Sensor directly to a driver transistor and relay to simply switch some apparatus on as long as a sound is present. That doesn't sound all that useful to me, though, since latching is probably what you want.

A better idea would be to use it to fire a 555 timer acting as monostable. When a burst of sound comes in, the timer goes on for a specified interval and then shuts off again. If you're going this route, remember that the 555 responds to a negative-going edge, so you'll probably want to differentiate and invert the output gate with, say, a simple transistor affair.

So, maybe you'd like to count handclaps or other sounds. That's easy to do. Just hook up the Sonic Sensor to some sort of CMOS counter like the 4017, 4024, 4026, 4511, or countless (groan ...) other such devices available. You could light a 10-element LED bar graph or perhaps a seven-segment LED display to show the number of bursts detected.

■ FIGURE 5.

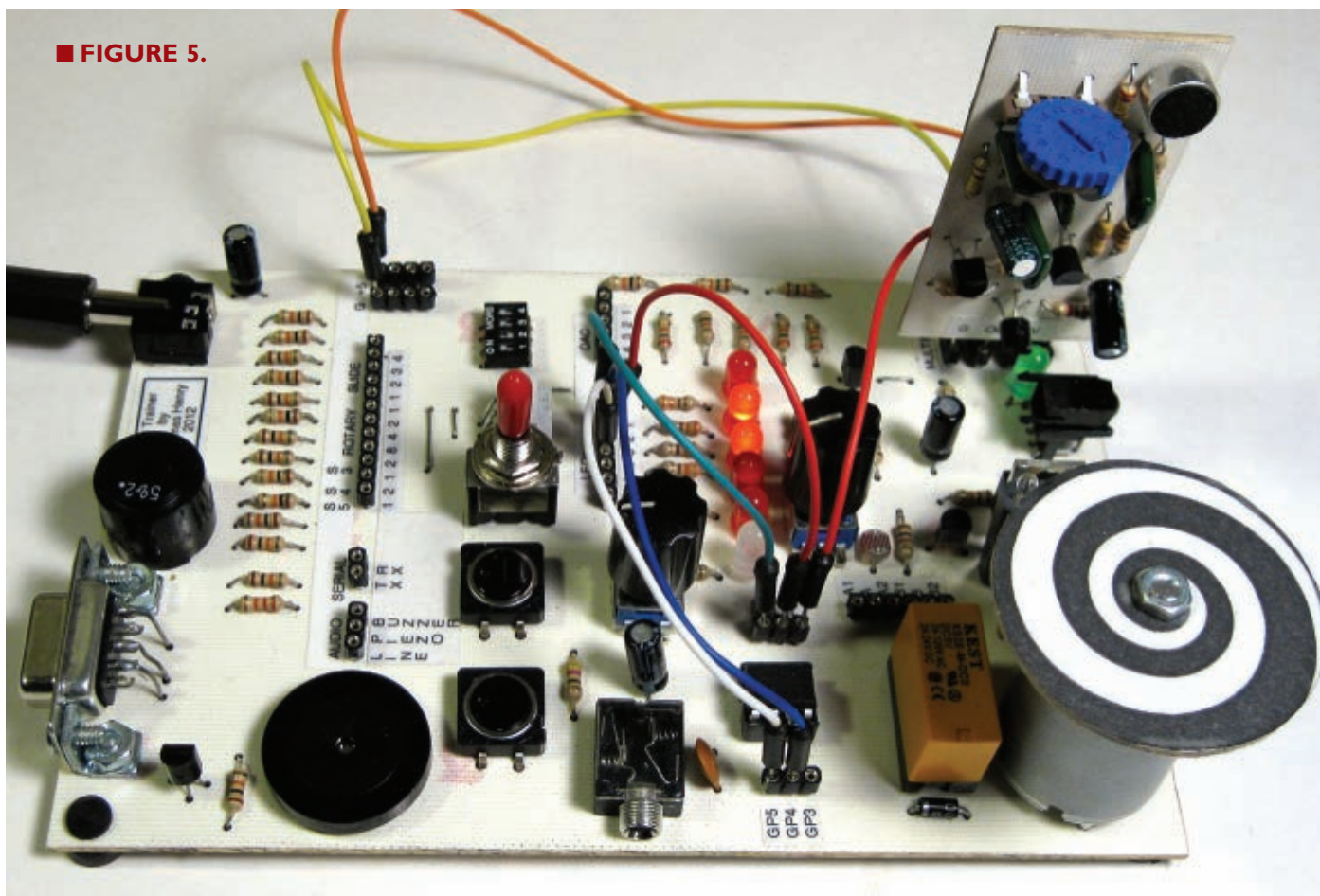

With the Sonic Sensor taking care of providing a gate or rising edge to fire a CMOS flip-flop or counter, the sky is the limit on what you can come up with.

For the most versatile approach possible, consider connecting it up to a microcontroller. The firmware can then do all sorts of things like count pulses, take averages, monitor intervals between bursts, check the clock times the sounds occur, route the results to buzzers, relays, motors ... you name it.

Just as one offhand example, suppose you own a summer cabin but don't expect to be there for several months. You could come up with a circuit that turns on floodlights whenever any crashing sound is heard (breaking glass, forced entry through a door, etc.).

Back to handclaps. I've provided two PIC12F683 programs written in the free and open-source Great Cow Basic language that are really pretty interesting; get them at the download link for this article. The first simply bumps a counter for each clap of the hands, showing the current count on some LEDs in binary.

The second program is even fancier and will start counting as soon as you start clapping, then stop the count when you stop. With this, you could control a large number of devices. For example, clap once and a lamp

turns on. Clap twice and it turns off. Clap three times and the radio turns on; clap four times and it turns off again. You can keep going like this almost indefinitely (limited only by the port pins of your microcontroller).

Unlike those commercial units of yesteryear, you now have the ability to put a large number of appliances under sonic control. The sample programs are heavily commented and also give any hookup instructions to the LEDs and so forth. Note too that the programs utilize one of the PIC timers in case you've ever wanted to learn more about them.

When testing my unit, I found I could get it to reliably count handclaps at a distance of up to 30 feet with the sensitivity set on max. Plus, it shouldn't really be any great hurdle to port the sample programs over to an Arduino should that be your weapon of choice.

One final thing before I turn you loose to whip up your own applications. Controlling AC devices like lamps, radios, televisions, etc., is serious business. So, be safe! Use properly implemented opto-couplers and relays to isolate the Sonic Sensor from any 110 VAC apparatus.

Now, what cool application can you come up with?

NV

Capacitor Discharge Ignition Kit for Motor Bikes

Many modern motor bikes use a Capacitor Discharge Ignition (CDI) to improve performance and enhance reliability. However, if the CDI ignition module fails, a replacement can be very expensive. This kit will replace many failed factory units and is suitable for engines that provide a positive capacitor voltage and have a separate trigger coil. Supplied with solder masked PCB and overlay, case and components. Some mounting hardware required.

- PCB: 45 x 64mm

Cat. KC-5466

\$16.00*

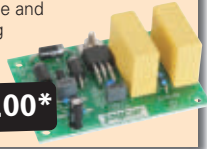

Battery Zapper Mk III Kit

Attacks a common cause of failure in lead acid* batteries: sulphation, which can send a battery to an early grave. The circuit produces short bursts of high levels of energy to reverse the sulphation effect. The battery condition checker is no longer included and the circuit has been updated and revamped to provide more reliable, long-term operation.

- Supplied PCB with solder mask and overlay, components, screen printed machined case
- 6, 12 & 24VDC

Cat. KC-5479

*Not recommended for use with gel batteries



\$57.75*

Jacob's Ladder MK3 Kit

A spectacular rising ladder of bright and noisy sparks for theatre special effects or to impress your friends. This improved circuit has even more zing and zap than it's previous design from April 2007 and requires the purchase of a 12V ignition coil (available from auto stores and parts recyclers).

- Kit supplied with silk-screened PCB, diecast enclosure (111 x 60 x 30mm), pre-programmed PIC, PCB mount components and pre-cut wire/ladder.
- Powered from a 12V 7Ah SLA or 12V car battery.

Cat. KC-5520

Battery not included

\$36.00*

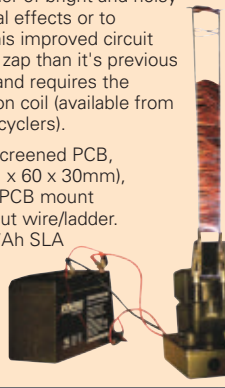

Smart Fuel Mixture Display Kit for Fuel Injected Cars

This improved model has an emergency lean-out alarm, better circuit protection and an auto dimming display. Another great feature is the 'dancing' display which operates when the ECU is operating in closed loop. Kit supplied with PCB and all electronic components.

- Car must be fitted with air flow and EGO sensors (standard on all EFI systems) for full functionality
- PCB: 121 x 59mm

Cat. KC-5374

\$21.75*



Digital Pulse Adjuster Kit

Allows you to control and tune the operation of any solenoid that is run by the engine management system. This means that you could control turbo boost without an expensive boost controller, or alter automatic transmission line pressures for better shifts. Alternatively, it can be used to drive and control an extra fuel injector.

- Kit supplied with a quality solder masked PCB with overlay, machined case with processed panels, 2 programmed micro and all electronic components
- Kit requires the Hand-held Digital Controller (KC-5386 \$49) and connecting cable (WC-7502 \$12) 25 pin extension cable with all pins connected)

Cat. KC-5384

\$57.75*



High Energy Ignition Kit for Cars

Use this kit to replace a failed ignition module or to upgrade a mechanical ignition system when restoring a vehicle. Also use with any ignition system that uses a single coil with points, hall effect/lumenition, reluctor or optical sensors (Crane and Piranha) and ECU.

- Kit supplied with silk-screened PCB, diecast enclosure (111 x 60 x 30mm), pre-programmed PIC and PCB mount components for four trigger/pickup options

Cat. KC-5513

\$36.00*



Interior Light Delay Kit

Many modern cars feature a time delay on the interior light. It still allows you time to buckle up and get organised before the light dims and finally goes out. This kit provides that feature for cars which don't already provide it. It has a soft fade out after a set time has elapsed, and features a much simpler universal wiring than our previous models.

- Kit supplied with PCB with overlay, and all electronic components
- Suitable for circuits switching ground or +12V or 24VDC
- PCB: 78 x 46mm

Cat. KC-5392

\$14.50*



Audio Kits

Bridge Mode Adaptor Kit for Stereo Amplifiers

This excellent kit will let you run a stereo amplifier in 'Bridged Mode' to effectively double the power available to drive a single speaker. There are no modifications required on the amplifier and the signal processing is done by this clever kit. Supplied with silk screened PCB and all specified components. Requires balanced (+/-) power supply from +/- 15 to +/- 60VDC.

- PCB: 103 x 85mm

Cat. KC-5469

\$20.25*

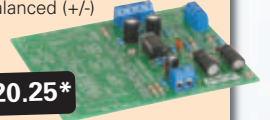

"The Champ" Audio Amplifier Kit

This tiny module uses the LM386 audio IC, and will deliver 0.5W into 8 ohms from a 9V supply making it ideal for all those basic audio projects. It features variable gain, will run from 4-12VDC and is smaller than a 9V battery, allowing it to fit into the tightest of spaces.

- PCB and electronic components included
- PCB: 46 x 26 mm

Cat. KC-5152

\$6.00*



Pro Monitor Headphones

Professional headphones that offer outstanding performance for home and studio applications. They provide accurate, linear sound reproduction to cater for the most demanding monitoring applications.

- Excellent bass response
- Ear cushions for comfort
- 120mW power handling
- Nominal impedance: 64 ohms
- Frequency response: 10Hz - 26kHz

Cat. AA-2065

\$62.00*



HUNDREDS SOLD

Frequency Switch Kit

This is a great module which can be adapted to suit a range of different applications. It uses a standard tacho, road speed, or many other pulse outputs to switch a relay. The switch frequency can be set to trip when it is rising or falling, and it features adjustable hysteresis (the difference between trigger on/off frequency). You could configure it to trigger water spray cooling on deceleration, shift light activation, adjustable aerodynamics based on speed, intake manifold switching and much more. Kit supplied with PCB, and all electronic components.

- PCB: 105 x 60mm

Cat. KC-5378

\$27.50*



HOW TO ORDER

PHONE: 1800 784 0263*

FAX: +61 2 8832 3118*

EMAIL: techstore@jaycar.com

POST: P.O. Box 7172 Silverwater DC NSW 1811 Australia

*Australian Eastern Standard Time (Monday - Friday 6.30am - 5.30pm)

*US Eastern Standard Time (Monday - Friday 4.30pm - 3.30am)

Prices valid until 30/09/2013

*ALL PRICES IN USD & EXCLUDE POSTAGE & PACKING

POST & PACKING CHARGES

5 - 6 day working delivery

Order value	Cost
\$25 - \$49.99	\$7.50
\$50 - \$99.99	\$20.00
\$100 - \$199.99	\$40.00
\$200 - \$499.99	\$60.00
\$500+	\$75.00

NOW shipping via DHL 5 - 6 working day delivery!

Max weight: 121B (5kg)
Heavier parcels: POA
Minimum order: \$25

ATTENTION KIT BUILDERS

Can't find the kit you are looking for? Try the Jaycar Kit Back Catalog

Our central warehouse keeps a quantity of older and slow-moving kits that can no longer be held in stores. A list of kits can be found on our website.

Just search for "kit back catalog".



Don't Just Sit There... Build Something!

BUILD THIS SIMPLE ALARM SYSTEM WITH THE TI LAUNCHPAD



By Derek Tombrello

Go to www.nutsvolts.com/index.php?/magazine/article/september2013_Tombrello for any additional files and/or downloads associated with this article. You can also discuss this topic at <http://forum.nutsvolts.com>.

Years ago, I designed a very simple alarm system for my shop that was armed and disarmed with a barrel key. The only components (aside from the door sensors and the siren itself) were a relay, a transistor, and a key switch. While that worked great, I had originally intended to (eventually) add a keypad interface, but never got around to it. Now, with Texas Instruments' low cost ultra-low-power MSP430 microprocessor, there was no reason to put it off any longer!



■ **FIGURE 1. Homemade ribbon cable connector.**

Everywhere you look, there are projects, tutorials, books, and accessories for every conceivable microprocessor – Arduino (and its clones); PICAXE; BASIC Stamp; Propeller – but almost nothing for the TI MSP430 Launchpad. Since it's priced at under \$5 for the development board, two uP ICs, and a USB cable, that is just plain sad. After a crash-course in C language programming, I was ready to dive in to my first project with the Launchpad.

The Bits and Pieces

The Keypad

The first thing you see is the keypad. I used a Datavision 12075 keypad (an Electronic Goldmine bargain) that features a 4 x 4 matrix keypad, six indicator LEDs (of which only two are needed) with built-in current limiting resistors, and a cutout for a piezo speaker element. The keypads being shipped by Goldmine now come with a mating female connector for the 16-pin thin film cable, but for mine I had to improvise. I found that if you glue a piece of single-sided printed circuit board (PCB) copper blank to the back of the film with contact cement, the cable is a perfect fit for an old 5-1/4" floppy drive connector.

As an added bonus, by cutting tracks across the copper blank, you're able to isolate pads to which you could solder the piezo buzzer's wires (to be added later). Refer to **Figure 1**.

One final modification has to be made to the keypad.

The indicator LEDs share a common ground with the keyboard matrix. For our purposes, this creates havoc in the decoder IC. To solve this, simply cut the ground traces going to the LEDs by cutting a small square out of the plastic film with an Xacto™ knife. Next, wire a new ground connection from one of the LED cathodes to one of the pads that you created on the copper blank (see **Figure 2**).

Now, hot-glue the piezo element into the cutout provided in the keypad. The negative terminal of the piezo connects to the same pad on the copper blank as the LED's ground wire. The other terminal is soldered to another one of the empty pads.

Keypad Decoder IC

The next component is the keyboard decoder IC. Since I had a few of the 74C922 decoder ICs in my junk box, it was an easy choice. It is, of course, an obsolete component, but they can still be found on eBay for less than \$3 a piece. Yes, the microprocessor does have enough I/O lines to implement a software keypad decoder, but since the 74C922 features full key debounce and multiple key press elimination, using a separate decoder IC lightens the amount of software code necessary.

When a key is pressed on the keypad, this IC sets the DATA_AV (Data Available) line high, alerting the microprocessor that data is available. In response, the processor brings the OE (Output Enable) line low whereby (as per the truth table found in the datasheet) a four-bit BCD is placed on the Data Output lines ABCD.

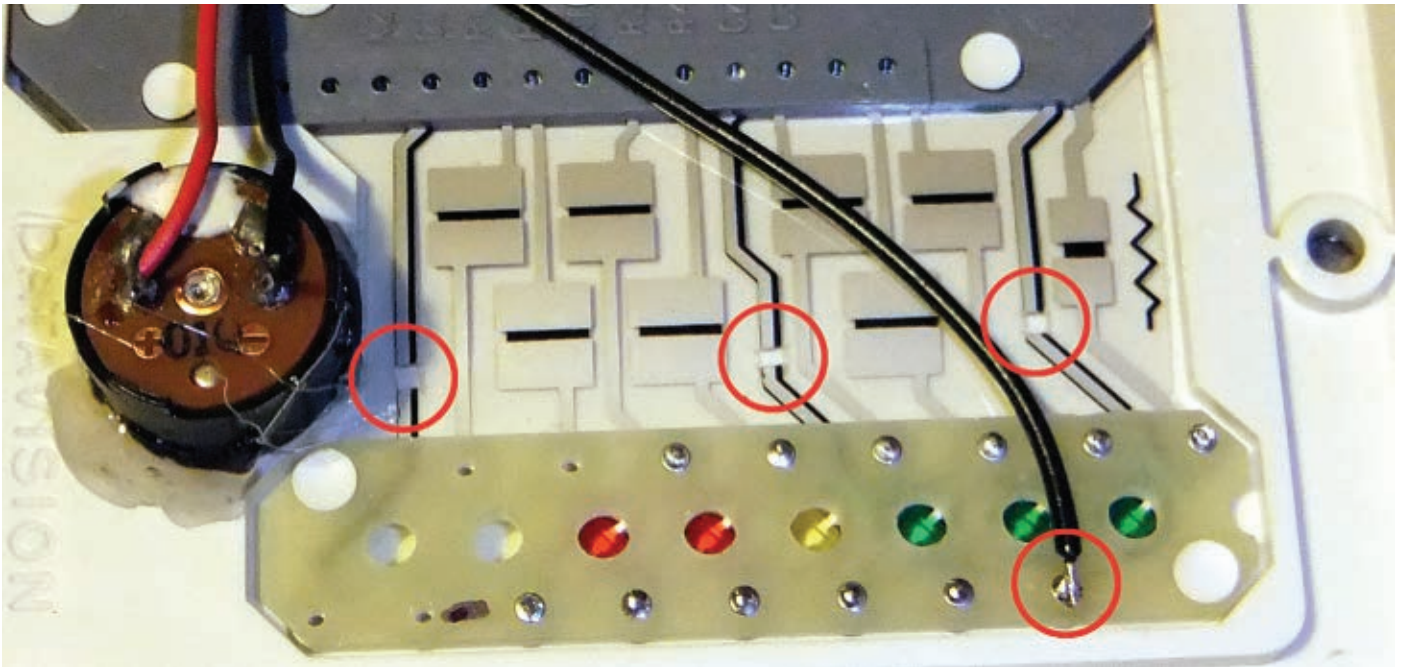

■ FIGURE 2. Cut traces and add ground wire as shown.

Qty	Description	Part Number	Source
Semiconductors			
3	1N4004 rectifier	1N4004GOS-ND	Digi-Key
1	L78L33 3.3V voltage regulator	497-7288-ND	Digi-Key
1	2N2222 NPN transistor	P2N2222AGOS-ND	Digi-Key
1	74C922 keypad decoder IC	74C922	eBay
1	MSP340G2452 processor IC	MSP430G2452IN20	Digi-Key
Resistors			
1	22 ohm 1/4 watt resistor		
1	470 ohm 1/4 watt resistor		
Capacitors			
1	0.01 μ F capacitor		
1	0.1 μ F capacitor		
1	1 μ F / 16V electrolytic capacitor		
1	47 μ F / 16V electrolytic capacitor		
1	1 μ F / 100V non-polar capacitor <i>(see text)</i>		
1	0.047 μ F / 5.5V memory backup capacitor <i>(see text)</i>		
Other			
1	Piezo buzzer (or similar)	PT-1245P-PQ	Digi-Key
1	Datavision 10275 keypad	G17927	Electronic Goldmine
1	Relay, SPDT 6 VDC coil <i>(see text for contact ratings)</i>		
	MSP-EXP430G2 development kit	MSP-EXP430G2	Digi-Key
	Magnetic reed security sensors, N/O contacts		
	Alarm siren <i>(see text)</i>		
	Cat-five cable		
	Perfboard 2" x 3"		
	6 VDC 500-1,000 mA wall-wart transformer		
	AC wall socket and plate (if using AC siren)		

PARTS LIST

www.digikey.com
www.goldmine-elec-products.com

Using a software look-up table, this four-bit nibble is translated into the key pressed.

Sensors

The door and window sensors are everyday run-of-the-mill magnetic reed switches. Four sensors are shown in the **schematic**, but as many (or as few) pairs as needed can be used as long as they are normally-open contacts and are wired in series. It goes without saying — so I'll go ahead and say it — make sure that the magnet and reed sensor are mounted securely on the door (or window). The reed sensor needs to be in as close proximity to the magnet as possible.

The Relay

I know that holding the relay open in stand-by mode is an inefficient design as far as power consumption is concerned, but there is a very good reason for this. This is an essential safety feature. If the lines going to the remote-mounted alarm siren or the keypad/interface power supply lines are cut, then the alarm will sound immediately. The relay contact requirements are determined by the specific siren you'll be using.

The Siren

My alarm is designed to sound an old 110 VAC mechanical siren that came out of an even older ultrasonic intrusion detection alarm. The relay then, of course, necessitates 110 VAC contacts at about three amps.

These sirens — while loud enough to be confused for air raid sirens — are hard to come by and are relatively expensive. You may want to substitute a 6-12 VDC siren.

While no where near as loud as their 110V counterparts, these are far easier to come by and can be had for under \$20. (See **Figure 3** for the schematic modifications required when using a low voltage siren.)

The Heart of the Project

The MSP430 is the heart of the project. Once programmed (either physically inserted in the development board or in-circuit using the development board as an ICSP programmer), the MSP430 processor requires no external components for operation.

This particular version (the 2452) features a 16-bit timer with three capture registers, up to 16 I/O pins, three distinct clock signals, an analog comparator, a 10-bit A/D converter, and a universal serial communication interface. Only one timer, one clock source, and 10 of the I/O lines are needed for this project.

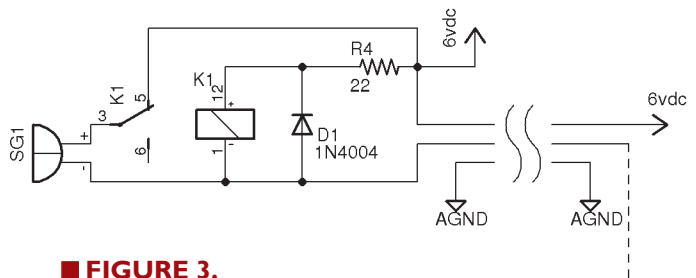

■ **FIGURE 3.**
Schematic modification
for 6-12 VDC siren.

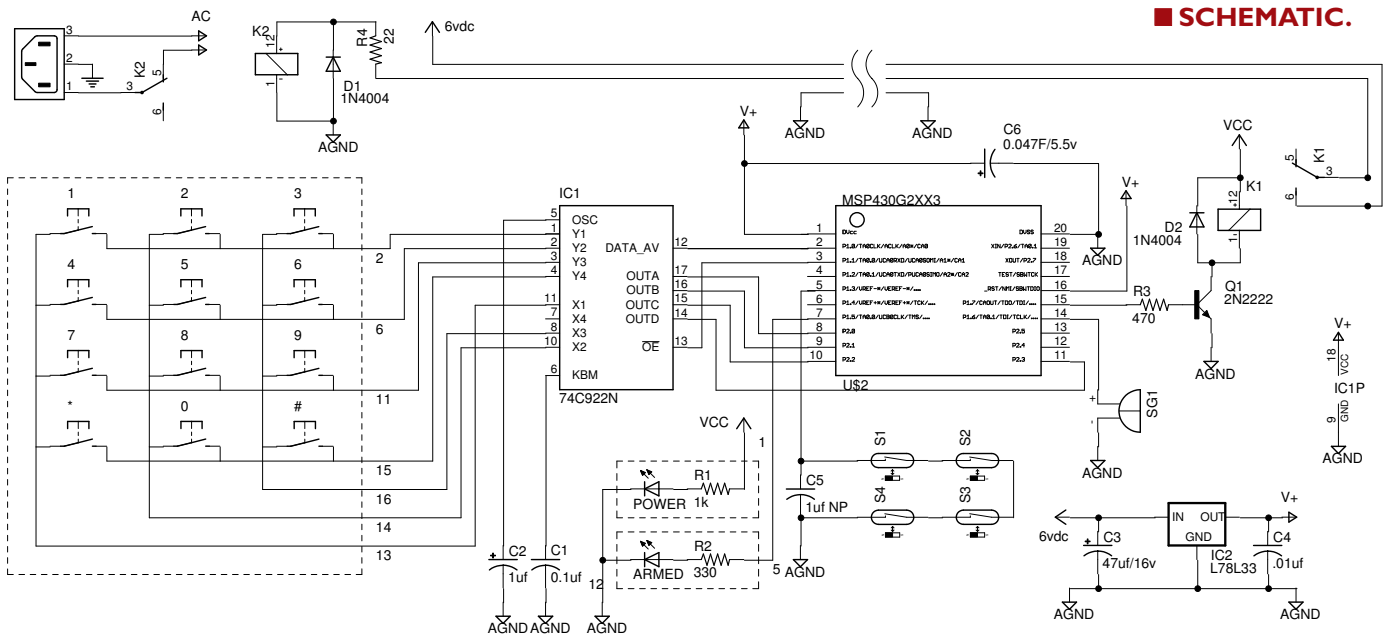

■ **SCHEMATIC.**

■ **FIGURE 4.** Completed circuit built on perfboard.

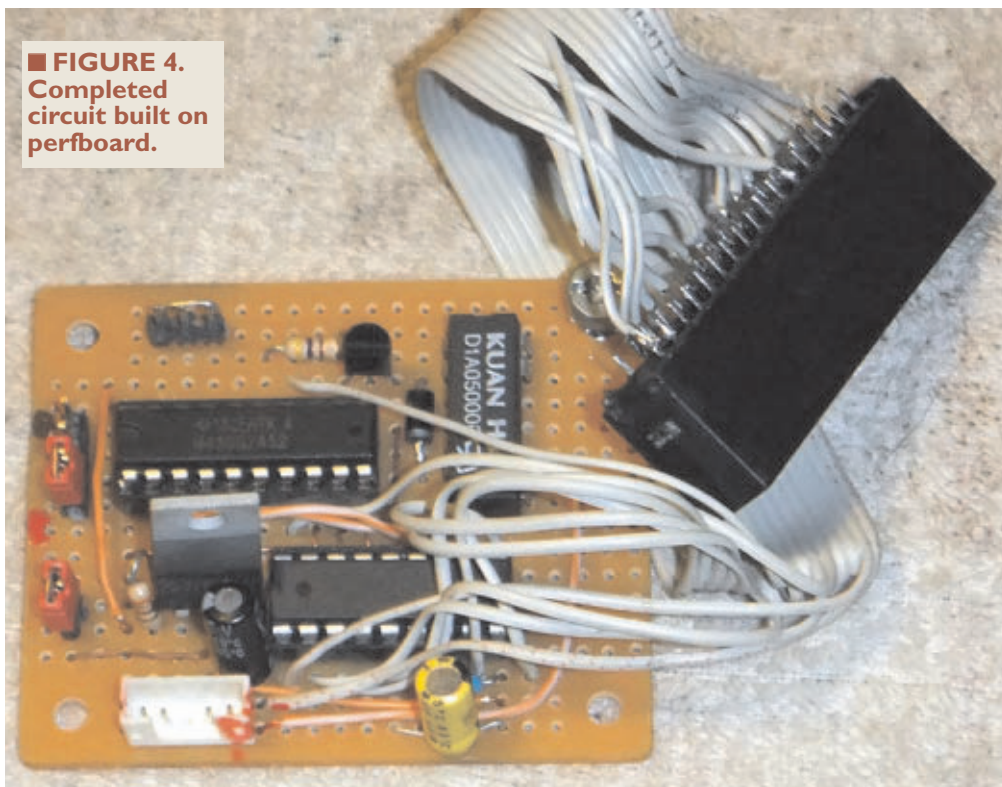

Additional Capacitors and Diodes (or Handling the Gremlins)

The long run of wire needed to connect the sensors in series tends to create a giant RF loop antenna. Fluorescent

lights, HVAC compressors, and other large motors can generate high voltage spikes which are then picked up by this antenna. These spikes will destroy the input circuits of the microprocessor. To prevent this, a 1 μF bipolar electrolytic capacitor is placed between the reed switch input on the processor and ground.

Additionally, 1,000V rectifiers are connected from that input pin to both the positive and negative rails in reverse (see **schematic**) to keep the voltage on that pin from going above or below the supply voltage by 0.3 volts.

Finally, a 0.047 μF memory backup capacitor is added across the positive and negative rails of the MSP to keep it powered during any minor power glitches that might otherwise cause the

processor to inadvertently reset.

Putting It All Together

The circuits I design are normally based on whatever I have on hand. This allows for a wide range of possible substitutions. The only component that really isn't easily substituted is the 74C922 matrix decoder, and really the only thing preventing the use of a different decoder IC is the software. Even the uP is flexible. The 2553 version is pin and code compatible with the 2452, and is a perfect drop-in replacement if more memory space is needed for future upgrades.

The entire circuit itself is basic enough that it can be built on a small 3" x 3" perfboard with point-to-point wiring, although an etched printed circuit board (PCB) would be simple enough to lay out (see **Figure 4**).

Any case (plastic or metal) that the keypad will fit in will work. I formed my own out of a sheet of light aluminum that I had (again) just laying around; refer to **Figure 5**. The datasheet for the keypad at Electronic Goldmine has a full-size template that aids in layout. The rest of it isn't critical.



■ **FIGURE 5.** The completed keypad interface.

(Pins 0 through 11)													
Switch Position		0 Y1, X1	1 Y1, X2	2 Y1, X3	3 Y1, X4	4 Y2, X1	5 Y2, X2	6 Y2, X3	7 Y2, X4	8 Y3, X1	9 Y3, X2	10 Y3, X3	11 Y3, X4
D													
A	A	0	1	0	1	0	1	0	1	0	1	0	1
T	B	0	0	1	1	0	0	1	1	0	0	1	1
A	C	0	0	0	0	1	1	1	1	0	0	0	0
O	D	0	0	0	0	0	0	0	0	1	1	1	1
U	E (Note 1)	0	0	0	0	0	0	0	0	0	0	0	0
T													

(Pins 12 through 19)										
Switch Position		12 Y4, X1	13 Y4, X2	14 Y4, X3	15 Y4, X4	16 Y5 (Note 1), X1	17 Y5 (Note 1), X2	18 Y5 (Note 1), X3	19 Y5 (Note 1), X4	
D										
A	A	0	1	0	1	0	1	0	1	
T	B	0	0	1	1	0	0	1	1	
A	C	1	1	1	1	0	0	0	0	
O	D	1	1	1	1	0	0	0	0	
U	E (Note 1)	0	0	0	0	1	1	1	1	
T										

Note 1: Omit for MM74C922

Figure 6. Truth Table for the 74C922 BCD matrix decoder.

The Code

This is where the magic happens. The ins and outs of C programming are beyond the scope and constraints of this article, but I will try to skim over the basics and the important bits.

In the Beginning

First, we have to do a little setup. The initialization of the three "tune" arrays (*OdeToJoy*, *FuneralMarch*, and *Charge*) are explained fully later on. The keypad lookup table needs to be explained, though. The 74C922 is designed to interface with a 4 x 4 matrix keypad. Going by the truth table for the 74C922 (see **Figure 6**), each numeric key would be decoded in sequence. Since we are missing an entire column of switches, that throws the numeric sequence off. To correct for this, we're using a software lookup table, replacing the missing column with 0s in the array:

```
const unsigned int lookup[15] = { 1, 2, 3, 0, 4,
5, 6, 0, 7, 8, 9, 0, 99, 0, 88 };
```

You'll notice that 99 is in position 13 and 88 is in position 15 (the first position in an array is 0, not 1). These are used to denote * and # respectively. This is explained in more detail shortly.

Next, we need to set up the internal clock sources. This means setting the main clock to 1 MHz and the auxiliary clock (ACLK) to the VLO frequency of about 10 kHz with a divisor of eight, or approximately 1,250 Hz. This is important to know because we then set one of the timers to trigger an interrupt every 6,250 cycles which equates to about every five seconds.

We also need to configure the I/O pins. For this project, we want to use pins P1.0, P1.3, and P2.0, 1, 2,

and 3 as inputs; the rest will be outputs. On pins P2.4, 5, and 6, we will need to utilize the MSP's internal pull-down resistors, while pin P1.3 will use the internal pull-up resistor. Finally, we enable interrupts for P1.0 and P1.3, and set the interrupt to trigger on the low-to-high transition.

When power is first applied (after the initial installation or after a power failure), the siren relay is energized and the system enters *DISABLED* mode. If the correct disarm code is not entered within 30 seconds, the system switches to *ENABLED* mode. This is to prevent the system from being defeated by a simple power interruption.

The processor is then set to run in *Low Power* mode where it is asleep for the majority of the time, waking up only when required to. This wake-up call is initiated by either a key being pressed on the keypad (P1.0 brought high by 74C922's DATA_AV), a break in the door/window sensors (P1.3 goes high), or a timer triggered event (~ every five seconds for housekeeping).

A Key is Pressed

If a key is pressed, then the software does a lookup of the signal presented to P2.0-P2.3 by 74C922's ABCD output pre-loaded into the array *lookup[]*. The first key press is multiplied by 1,000; the second key press by 100; the third key press by 10; and the fourth key press by one. Each result is added to the previous to get a total (stored in *entered*). For example, if you entered 6, 4, 3, 2, then the total would be:

$$(6 \times 1000) + (4 \times 100) + (3 \times 10) + (2 \times 1) = 6432$$

This gives the software a number that it can compare

to the keycode hard-coded into the variable *CODE* (which will need to be set before the processor is programmed).

If a key isn't pressed within five seconds, the previous digits entered are erased and the code must be entered again from the beginning. This prevents you from entering, say, three of the four digits and walking away. Someone could possibly get lucky and hit the last digit by accident.

When the correct code is entered (*entered* = *CODE*), the alarm is disabled (by setting the variable *alarmState* to *DISABLED*). The siren relay is energized (turning the siren off) by pulling P1.7 high. Then, this is where I got a little creative. Stored in the ROM are the musical notes for Beethoven's "Ode to Joy" — a favorite of mine. When you enter the correct code to disarm the system, the function *PlayMusic* will sound the first few bars of Ode to Joy using pulse width modulation (PWM). The * key is assigned a value of 99 in the lookup table and the key # is assigned 88. This allows the software to test for a result of 99880, which occurs when the code *0# is input:

```
(99 x 1000) + (88 x 100) + (0 x 10) = 99880
// in this case only three digits are collected
```

*0# is the three-digit code used to arm the system. When this code is entered, *alarmState* is set to *ENABLED* and the tune "da-da-da-da ... da-da ... Charge!" is played. You then have 30 seconds (as defined by the constant *ALARM_DELAY*) to exit the building and close the doors before the alarm is triggered. If you leave a door open after enabling the system, the siren will sound to alert you, in which case you will have to re-enter the disarm code.

A Door/Window is Opened

When a sensor is interrupted — a door or window is opened — then P1.3 is pulled by an internal pull-up resistor. A software debounce tests P1.3 over a half-second period to see if the signal goes low again. If it does, the system assumes it was a glitch and goes back to sleep. This is necessary to prevent false triggers.

You then have 30 seconds (*ALARM_DELAY*) to enter the correct code and disarm the system. If the correct code is not entered in time, the siren relay is de-energized, sounding the siren. The siren will continue to sound until the disarm code is entered.

Attempts to find the code by brute-force (randomly or sequentially trying numbers) are limited to three tries at a time. After three incorrect attempts, the "Funeral March" is played and the keypad is locked (or rather ignored) for five minutes. During this time, the controller will not respond to any further key presses.

Important Notes

The code (available at the article link) is fully annotated so it should be easy enough to follow what is going on. I would like to point out a couple of items, though. As I said, you will need to set *CODE* to whatever

four-digit disarm code you would like. You can also change *ALARM_DELAY* to any value (in multiples of five) to give a longer or shorter timeframe in which to leave or enter the building before triggering the alarm. The tunes played are stored in the arrays *OdeToJoy[]*, *FuneralMarch[]*, and *Charge[]* in this format:

```
{note, duration, ...}
where note = a, b, c, d, e, f or g on the
treble clef and a3, b3, c3, d3, e3, f3 or g3
on the bass clef
and duration = whole, half, dquarter (dotted
quarter), quarter, eighth, deighth (dotted
eighth) or sixteenth.
```

These can be tailored to suit your preferences, but remember that space is limited so try to keep tunes short.

Final Assembly

In my application, the 6 VDC in the schematic is supplied by a 500-1,000 mA wall-wart transformer located in the attic. Also in the attic is the siren, the siren relay, and an uninterruptable power supply (UPS). The wall-wart transformer and the siren relay contacts (labeled AC on the schematic) are plugged into the UPS which is plugged into an available AC outlet. In case of a power outage (or a burglar cutting the power lines), the alarm is still powered. Using a UPS allowed for a simpler circuit design since I didn't have to incorporate a battery backup feature. I replaced the built-in battery in my UPS with a lawnmower battery for a longer run time, but that is optional.

The keypad interface is connected to the siren relay and power supply with Cat-5 cable (or any multi-strand cable). I had Cat-5 on hand and the additional leads allow for future upgrades.

Improvements

There is room for improvement in any project and this one is no exception. For starters, I would like to include an LCD display to show the code as it's entered and to provide feedback to the user (in conjunction with the LEDs that are being used now). This would make it easier to change the disarm code in real time as opposed to it having to be hard-coded. Without the visual feedback an LCD would offer, the possibility of error would be greater when changing the key code. I also plan to incorporate an auto-dialer so that the police can be called with a pre-recorded message when the alarm is tripped. This could be either an old-fashioned landline dialer or any unused cell phone could be re-purposed (since even unactivated cell phones can dial 911 free of charge).

With up to seven free I/O lines still available, the sky is the limit as to what can be done with this basic alarm system — all built around a \$4 computer chip! **NV**

The Convenient All-in-One Solution for Custom-Designed Front Panels & Enclosures



ONLY \$90.24
with custom
logo engraving

You design it
to your specifications using
our FREE CAD software,
Front Panel Designer

We machine it
and ship to you a
professionally finished product,
no minimum quantity required

- Cost effective prototypes and production runs with no setup charges
- Powder-coated and anodized finishes in various colors
- Select from aluminum, acrylic or provide your own material
- Standard lead time in 5 days or express manufacturing in 3 or 1 days

**FRONT PANEL
EXPRESS**

FrontPanelExpress.com
1(800)FPE-9060



AP CIRCUITS
PCB Fabrication Since 1984

As low as...

\$9.95
each!

Two Boards
Two Layers
Two Masks
One Legend

Unmasked boards ship next day!

www.apcircuits.com



Superior Quality Soldering Tools from

HAKKO



FX-951

**HIGH PERFORMANCE
SOLDERING STATION**

- Digital temperature display
- Superior heat transfer
- Fast thermal recovery
- 400°- 840°F (200°- 450°C)
- Low temperature alarm
- Sleep mode for longer tip life

FX-601

**TEMP-ADJUSTABLE
SOLDERING IRON**

- Electronic "closed loop" control
- 464°-1004°F (240°- 540°C)
- Ceramic heating element
- Lightweight (2.4oz w/o cord)
- Extra long 3-plug, 6 ft.cord
- UL/CSA Approved

FX-888D

**LOW COST, DIGITAL
SOLDERING STATION**

- Digital display (°F or °C)
- Adjustable temperature
- 120°-899°F (50°- 480°C)
- Idle temp within 1.8°F (1°C)
- Ergonomic, handpiece
- Ceramic heater

For complete information, visit HakkoUSA.com/NutsVolts



Steve, thanks for the feedback!

1. There are some typos in the DC/DC converter text and schematic. The correct name is TPS62730.

2. The PUMH10 does use bipolar transistors, not MOSFETs. As for driving the camera directly, note that the pullup voltage on the camera is unknown. Some cameras can be as high as six volts.

3. Correct. The CR2032 is a lithium manganese battery with a floating voltage just above 3.0V. This is different than common lithium-ion batteries which have a voltage of 3.6V.

4. There is an error in the figure. The 1M pulldown resistor is supposed to be connected to "shutter," not "detect." When unplugged, shutter and detect are shorted together and the 1M pulldown serves to keep the circuit off. When plugged, the detect line is isolated and will be pulled up by the 10M resistor to turn on the device.

5. The choice of having a female connector on the

dongle was mostly driven by the cost of packaging. Putting a single hole in the polycase enclosure is simply the least expensive option.

As a final point, the battery life can be extended by changing the inverter used in the circuit to a lower power logic family (74AUP instead of 74AHC). The new part number is Mouser #595-SN74AUP1G04DBVR. This is the part we are shipping in the kits.

Michael Wieckowski, Ph.D.

Inductor Errata

I found a mistake in Figure 10 from my induction charger project in the August 2013 issue. The current limiting resistor "R8" should be connected to [IN] which is the 4.35 to 6.5 volt input. To the left is a revised schematic.

Matthew Bates

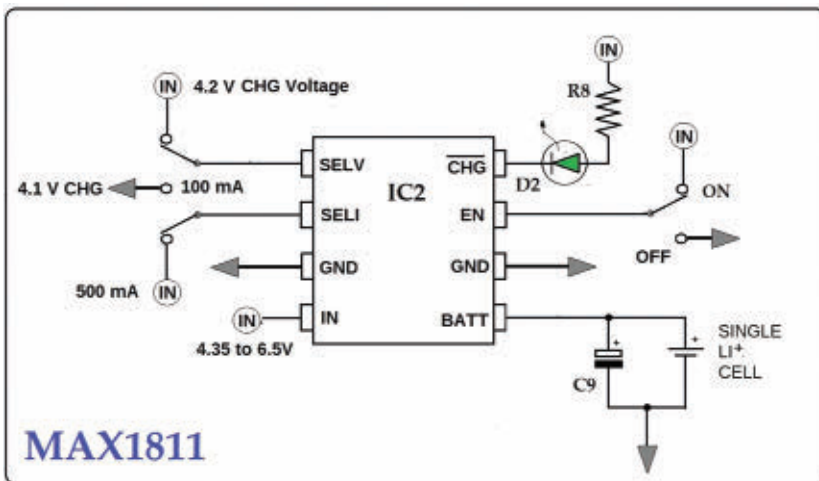

Keeping Tabs on Batteries

Regarding Bryan Bergeron's editorial from the July 2013 issue on li-ion battery tech: Next time, install the battery with a piece of paper (a paper tab), blocking one pole from connecting to the circuit. This is commonly done with LED flashlights and kid's toys.

Phil KE3FL

Matching Tubes

I read Steve Borsher's letter regarding tubes in the June 2013 issue with much interest. I was a service tech at the Canadian national distributor for Dynaco back in the late '70s and serviced many Dynaco amplifiers — some of which were the MKIII and MKVI.



PBP3

PICBASIC PRO™ Compiler

Experimenter - \$49.95
Silver Edition - \$119.95
Gold Edition - \$269.95

The industry-standard BASIC compiler for Microchip PIC® microcontrollers.

Multi-Seat Licensing
for Educational Institutions

Upgrade from
PICBASIC™ Compiler (PBC)

Download a FREE trial version now.

www.PBP3.com

microEngineering Labs, Inc.

www.melabs.com

888-316-1753

PICBASIC and PICBASIC PRO are trademarks of Microchip Technology Inc. in the USA and other countries. PIC is a registered trademark of Microchip Technology Inc. in the USA and other countries.

I do remember the output tubes (KT88s) being sold in matched pairs. They were supplied to us by Dynaco already "matched." There were no test sheets included; the boxes were glued together indicating they were a matched pair.

Maybe the fact that they were being sent to a service center and would more than likely be used in a customer repair instead of being sold over the counter to the owner directly had something to do with it.

As a service tech, I soon realized that matching the tubes could become compromised if certain components in the circuit associated with the output stage were off value or not exactly matching — especially in the MKVIs when comparing the left and right channels. No matter if the tubes were "matched" or not, components that were off value were more of an issue to performance quality and tube life.

In my opinion, the best way to make sure that matching the tubes is maximized is to verify the components — especially any carbon resistors and capacitors in the associated circuitry. Adjust the bias properly and always use eight ohm load resistors paralleled to the inputs of a dual trace scope with the input

signal coming from a sine/square wave generator to see if — all combined — the circuitry end product is truly matched. I use this technique when servicing Marshall and Fender heads to this day, and it always gives me good results.

How did the tube supplier "match" the tubes? I'm not really too sure, but I would assume that they used some sort of jig setup where they measured

certain parameters of each tube from a large batch of tubes and then put them together as pairs as close as they came to having similar values/readings. It would be interesting if any of the readers could shed some light on this matter, and maybe describe the kind of setup that tube manufacturers actually use for matching vacuum tubes.

David Asselin

Repair Monitors, Power Supplies, Gameboards? Check any Electrolytic Capacitor *In-Circuit* with 100% Accuracy in 3 Seconds---**GUARANTEED***

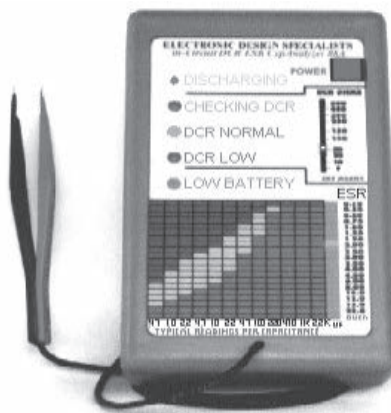

Automatically discharges capacitor

Checks DCR with alerts for shorts

Measures DCR to 500 ohms

Measures ESR from 0.1 to 20 ohms

Checks caps from .47uF to 2200uF

Beeps one to five beeps for quality

Three-color chart for good-fair-bad

*range 0.47uF - 2.2KuF 90-day money-back guarantee

Portable, Easy to Use, Inexpensive, Highly Recommended by
leaders in the industry. **CapAnalyzer 88A** by EDS, Inc.
At your favorite distributor, or call 561-487-6103 www.eds-inc.com

Electronix EXPRESS

Visit our website at <http://www.elexp.com>

RSR-III— 3MHZ SWEEP FUNCTION GENERATORS 6 Waveform Functions, Int/Ext Counter, lin/log sweep MODEL FG-30 (No Digital Display) \$135 ⁰⁰ MODEL FG-32 (5 Digit Display) \$195 ⁰⁰	GW INSTEK OSCILLOSCOPE MODEL GDS1042 Dual Channel 40MHZ DSO	DC POWER SUPPLIES MODEL HY3003 — DIGITAL DISPLAY Variable output, 0-30 VDC, 0-3 Amp \$95 ⁰⁰ MODEL HY3003-3 — TRIPLE OUTPUT Two 0-30 VDC, 0-3 Amp variable outputs plus 5V 3A fixed. Digital Display. \$184 ⁰⁰	Weller® SOLDERING STATION #1 BEST SELLING \$46 ⁵⁰ STATION MODEL WLC 100 0603WLC100	RIGOL 100 MHZ DSO DS1102 \$399
BENCH DMM WITH RS232 INTERFACE MODEL DM9803R True RMS, digital and bar graph display, AC/DC Cap, Res, frequency functions. Includes software, AC or DC operation. \$139 ⁹⁵	DIGITAL MULTIMETER 32 Ranges — 3 1/2 Digit MODEL MY-64 \$33 ⁹⁵ AC/DC Volt/Current, Res. Cap., Frequency. Rubber Holster Included	ALLIGATOR LEADS SET OF 10 \$3 ⁵⁰	RSR-III— HIGH PERFORMANCE 3-WIRE IRON #060509 \$7 ⁵⁰	RSR-III— DIGITAL SUPER ECONOMY MULTIMETER MODEL 820B 1-9 \$7.50 #01DM820B
SWITCHES 8 POS DIP (V17DIP8SS) 1-9 .90 10+ .85 Toggle Mini SPDT (17TOGSD-M) 1.40 1.20 Toggle Mini DPDT (17TOGDD-M) \$1.55 1.35	POTENTIOMETERS Cermet (STS Series) 1-9 85¢ 10-99 75¢ 100+ 65¢ Multiturn (MTT Series) 70¢ 60¢ 45¢ Panel Mount (PMA Series) \$1.15 80¢ 70¢ Standard Values Available	SOUND SENSOR CAR REQUIRES SOLDERING Reverses direction whenever it detects noise, or touches an obstacle. \$9 ⁹⁵ #3221881	MORE Low-Priced Items In Our FREE 350+ Page Catalog	

TERMS: Min. \$20 + shipping. School Purchase Orders, VISA/ MC, Money Order, Prepaid. NO PERSONAL CHECKS, NO COD. NJ Residents: Add 7% Sales Tax.

In NJ: 732-381-8020
FAX: 732-381-1006

900 Hart Street • Rahway, NJ 07065
800-972-2225

<http://www.elexp.com>
email: electron@elexp.com

Full Color With One Wire

There's no denying that the ubiquitous blinking LED demo is the "Hello, World!" of embedded programming. In fact, many microcontroller boards — like the Propeller QuickStart and the Arduino — come with pre-installed LEDs so that we don't have to connect anything to get started. With cheap and easy LCDs — and even the ability to do video with some micros — LEDs seemed to fall out of favor for a while. You know the saying, though: Everything old is new again. LED manufacturers are creating some really neat products these days, and with a small matter of programming, we can have a lot of fun with them.

Go to www.nutsvolts.com/index.php?/magazine/article/september2013_SpinZone for any additional files and/or downloads associated with this article. You can also discuss this topic at <http://forum.nutsvolts.com>.

Back in November 2012, I wrote about using the WS2801 RGB LED driver, and shared how I was able to deploy it in a big "Hollywood" creation built by my friends at Steve Wang's Biomorphs. The League of Legends display was built for Riot Games, and is a crowd favorite at gaming conventions across the country.

For review, the WS2801 is an RGB LED controller that acts like a shift register, accepting 24 bits (eight bits for each color channel), then allowing additional bits to pass through to other devices in the string. A brief low period on the clock line causes the device to reset and accept new data. Being SPI-like with separate clock and data lines, it's very easy to use — any controller of any speed can send data to a WS2801. **Figure 1** shows a segment from the WS2801 LED strip.

Note the size of the LED that is right in the middle of that strip; it's tiny — just 5 mm x 5 mm. Now, imagine if a vendor could jam that driver chip on the left side of the segment into the body of the LED. There's no need to imagine; they've done it. It's called the WS2812.

Let me clarify just a bit. The WS2801 is a two-wire (clock and data) device. There is a similar device called a WS2811 that uses a single wire and different protocol. It is the WS2811 that is packed into an RGB LED to form the WS2812. Being a single-wire device, the WS2801 code won't work with WS2811 chips or WS2812 LEDs. It's time for some new code.

So far as I can tell, one of the best places for hobbyists to get WS2812 products is from Adafruit in New York. That said, if you want help using the WS2812 with the Propeller, you're basically out of luck since they specialize in Arduino. They have a nice driver that works with most Arduino variants, but suggest if you're using something else, Google is most likely your best friend.

Well, there's no need to entertain basement-dwelling government employees with another Google search — the WS2812 datasheet is available on the product page for the LED (raw form). For initial experiments, I recommend their NeoPixel (version 1, #1312) modules. For about eight bucks, you get four WS2812 modules. Note that they don't come with pins installed for use with a breadboard. Wearable electronics is a popular topic at Adafruit, so the NeoPixels come without pins; this makes them easier to sew onto fabric. It takes just a few seconds

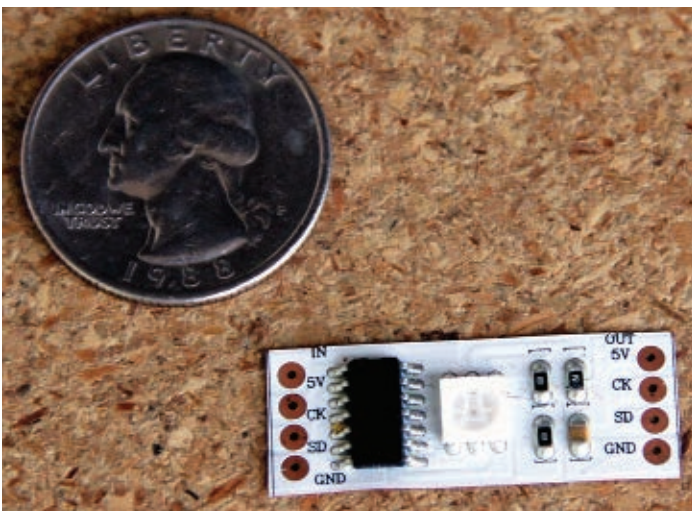

■ FIGURE 1. WS2801 segment.

to solder a couple 1x3 male headers into the module to make it breadboard friendly. When you're done, the module will look like the one in **Figure 2**.

Down the line, I intend to roll my own. **Figure 3** is the schematic for my JM_Pixel module (Adafruit does not provide a schematic for the NeoPixel). There's nothing magic about this circuit; it's taken right from the WS2812 datasheet. The RC components between VDD and VCC keep PWM noise on the VDD line from bothering the control electronics (which are connected to VCC). Easy peasy. Serial data is fed into DIN. When the device has received 24 bits, the rest of the stream will be directed to DOUT for other modules.

The signal from the DOUT pin is re-shaped and amplified so that it doesn't degrade as data propagates from LED to LED. According to the datasheet, we can have up to five meters of wire between WS2812 modules. I'm not sure I'd push it that far, but I like that they don't have to be right on top of each other.

One note on my version (see **Figure 4**): The pins are organized differently than the NeoPixel; my printed circuit board (PCB) layout matches the polarity of female-to-female servo extender cables. I've included DipTrace files and Gerbers for the JM_Pixel. If you order from Bay Area Circuits (see File Menu in DipTrace PCB) using the 10-day production schedule, you can get 100 boards for about \$36 with shipping. Add \$0.50 for the LED (from Adafruit) and another dime for the resistor and capacitor, and you can build your own pixels for about a buck each – if you're willing to do the soldering.

Cracking the WS2812 Code

As a programmer, I do my best to wear a "Captain Obvious" costume so that everyone can understand what I'm doing – and most of the time it works. To that end, I like to specify RGB colors in my projects as a long value in the form \$RR_GG_BB. Here's the rub: The WS2812 wants the 24-bit packet to arrive as \$GG_RR_BB (the RR and GG bytes are swapped).

It's easy to swap a couple



■ FIGURE 2. NeoPixel module.

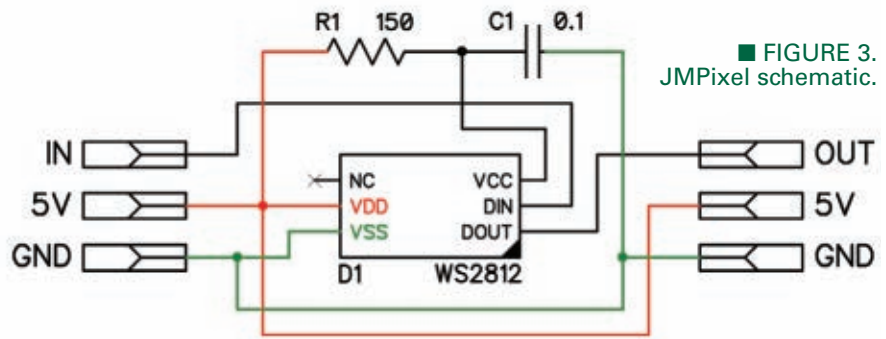

■ FIGURE 3. JMPixel schematic.

bytes in code, but on asking for suggestions in the Propeller forum, a really interesting discussion ensued and in the end, the most clever solution – in my opinion – was by TonyP12 (his handle) who is a frequent and very helpful contributor in the Parallax forums. He came up with a trick that eliminates nine lines of code and three

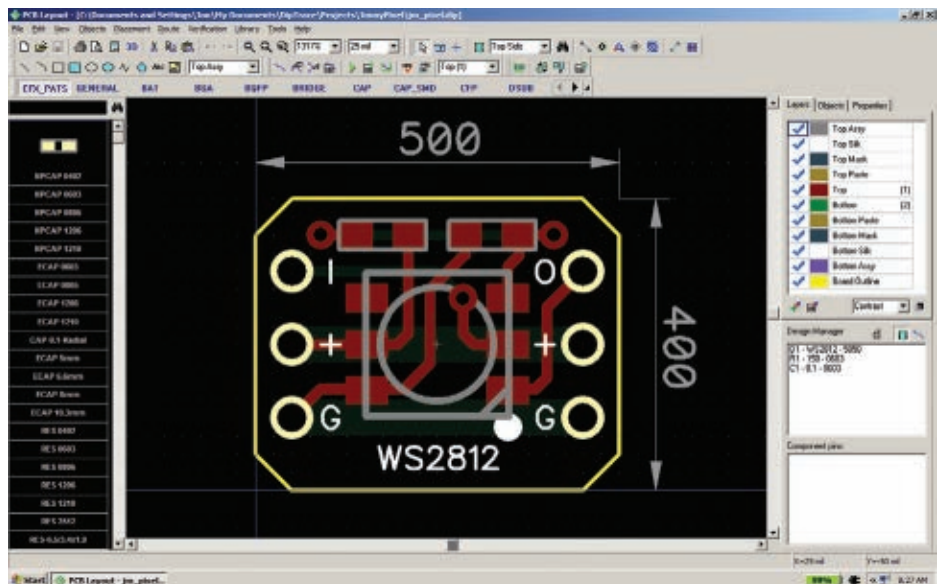

■ FIGURE 4. JMPixel PCB.

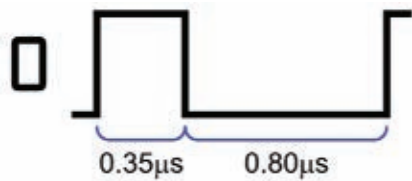

■ FIGURE 5.
WS2812 bit timing.

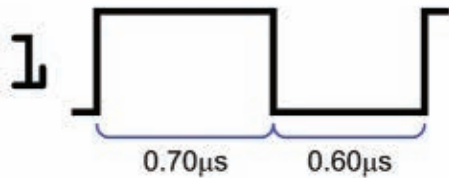

constants from my original driver.

Okay, the truth is that it didn't really matter here; the driver is tiny and there was no issue with resources. This won't always be the case, however, and in this project I'm going to show you techniques used by advanced Propeller programmers to save cog resources. A big part of the reason I write this column is to help others learn to program the Propeller so that they don't have to count on an object being available; it's much more fun to write one's own code, anyway.

Let's have a look at the protocol. The WS2812 wants the data line to be quiet (low) for at least 50 microseconds to perform a reset. After this, it will read 24 bits — most significant bit (MSB) first — into the green, red, and blue color registers. Additional bits on the data input are re-routed to the data output until the next reset period.

With just one line, the data is asynchronous, though it uses a slot-based RTZ (return to zero) signaling scheme. The bit value is based on the time the data line is high at the beginning of the ~1.25 microsecond slot. A zero bit has a high time of 0.35 microseconds with a low time of 0.8 microseconds; a one bit has a high time of 0.7 microseconds with a low time of 0.6 microseconds (see **Figure 5**).

If you do, in fact, conduct a Google search for a WS2812 driver you'll find a lot of consternation over writing code to meet the somewhat tricky timing specs. Pardon me for being partisan, but this is where the Propeller just kicks the stuffing out of the Arduino. By using a dedicated processor, I was able to write my original driver in about 20 minutes, and it worked the first time without tuning. Let me show you what I did and the final product based on some really great interaction with other programmers in the Propeller forum.

Getting Started with the WS2812

To connect to the WS2812 driver, we need to specify an output pin and tell the driver how many LEDs we have in the string. As written, the driver will support up to 64 RGB LEDs, but this is easily adjusted with a constant in the

driver object. As with most Propeller objects, the **.start()** method sets up parameters used by the driver cog, and then launches it:

```
pub start(pin, leds) | ustix

    stop
    dira[pin] := 0

    ustix := clkfreq / 1_000_000

    txp      := pin
    stringsize := 1 #> leds <# MAX_LEDS
    resetticks := ustix * 55
    t0h      := ustix * 35 / 100
    t0l      := ustix * 80 / 100
    t1h      := ustix * 70 / 100
    t1l      := ustix * 60 / 100
    bufaddr  := @rgbbuf

    cog := cognew(@ws2812, @txp) + 1

    return cog
```

This is pretty self-explanatory. We're setting up the pin used, the number of LEDs to update, and the timing parameters for the driver. The final parameter is the hub address; the driver needs to know where we're storing color values for it to transmit.

If you look carefully, you'll see that there are eight longs that we need to transfer to the PASM cog that implement the driver. After initializing everything, we pass the starting address of the block (**@txp**) in the **cognew** instruction.

Let's have a look at the PASM code that copies these values from the hub RAM into the cog RAM. In some objects with just a few parameters, we'll typically do something like this:

```
dat

                                org      0

ws2812                          mov      t1, par
                                rdlong   txpin, t1
                                add      t1, #4
                                rdlong   ledcount, t1
                                add      t1, #4
                                rdlong   resettix, t1
```

Remember that the address passed in **cognew** will be available to the cog in the **par** register. We can use this as the starting point to moving values from the hub to the cog. This is fine with just a few parameters, but gets long-winded beyond that. With about the same amount of code as shown above, we can copy as many parameters as we have from the hub to the cog:

```
dat

                                org      0

ws2812                          mov      t1, par
                                movd     :read, #txpin
                                mov      t2, #8
```

```

:read      rdlong   0-0, t1
          add     t1, #4
          add     :read, INC_DEST
          djnz   t2, #:read

```

This particular section of code will copy eight longs from the hub into the cog. By changing the initial assignment of *t2*, we can transfer as many values as we choose. Let's go through it line by line so that it all makes sense. This code is self-modifying, hence needs to be approached with some care:

```
ws2812     mov     t1, par
```

Okay, this one's easy. We're copying the value in *par* (the address of *txp* in the hub) into cog variable *t1*. Keep in mind that *t1* now holds the address of a long, that all parameters are longs, and that they are assigned in contiguous order in the hub:

```
movd      :read, #txpin
```

This is the first line of self-modifying code. The **movd** (move to destination) instruction will take the cog address (#) of *txpin* and move it into the destination field of the instruction at label **:read**.

Wow, that was a mouthful, but it's important. If you skip ahead and look at the instruction at **:read**, you'll see 0-0 in the destination field. This is a note to other programmers that this field will be modified by the code:

```
mov      t2, #8
```

Easy peasy: Move eight (the parameter count) into *t2*:

```
:read     rdlong  0-0, t1
```

This is the instruction that does the work. It reads a long from the hub in the address held by *t1* and writes it into the cog address held in the destination field. We initially set *t1* to the hub address of *txp*, and the destination field to the cog address of *txpin*:

```
add      t1, #4
```

This line adds four to *t1* (hub address); we need to add four because the cog sees the hub as a big array of

bytes, and there are four bytes in a long:

```
add      :read, INC_DEST
```

This is the second line that modifies the code. In this case, the value of *INC_DEST* will cause one to be added to the destination field of the instruction at **:read**. A defined value (cog constant) is required here because PASM will only allow inline literals up to 511. The reason that we increment the destination by one instead of four is that the Propeller views the cog as an array of longs:

```
djnz     t2, #:read
```

Finally, we decrement the value in *t2*. If it is not zero, jump back to the instruction at **:read**.

To review, we set a pointer to a block in the hub; another pointer to a block in the cog; then run a loop that uses **rdlong** to move the block — long by long — from the hub to the cog. It is critical that the block of variables in the cog match the count and order of the parameters in the hub. Another important issue with self-modifying code is that the Propeller's instruction pipeline necessitates having at least one instruction between the code that makes the modification and running the line that was modified.

Most of the values are for timing, so we don't need to do anything with them right away. The pin used for transmitting data to the WS2812 chain needs to be converted to a bit mask, and then that pin be set up as an output and low:

```
mov      txmask, #1
shl     txmask, txpin
andn    outa, txmask
or      dira, txmask
```

This process is straightforward. We move one into *txmask* and then shift that left by the value in *txpin* to create a mask. The output bit for that pin is cleared (to 0) by using **andn** (and not) with the mask, and then the pin is made an output by ORing the mask with the directions register (**dira**). For those that are new to the Propeller, it uses a one in a direction register bit to set a pin to output mode.

Okay, then. We're ready to rock. At this point, the driver drops into the main loop where it performs a reset timing, then reads the color values from the hub and transmits them using the WS2812 protocol. After all the channels have been sent, the code loops back to the top and starts over.

What this means for us is that we can modify the color array and not worry about anything else. We don't have to tell the driver to send the new color values; once the driver is started, it will continuously update the LED string until we tell it to stop. From a timing perspective, it takes about 30 microseconds to send the color values to

BILL OF MATERIALS

C1	0.1 µF	Mouser# 77-VJ0603Y104JXPBC
D1	WS2812	Adafruit #1379
R1	150 ohm	Mouser #660-RK73H1JTDD1500F
PCB		DipTrace/Bay Area Circuits

each LED, and we do need a 50 microsecond reset period before each frame. In practical terms, this means that we could update a 16x16 array of WS2812 LEDs in under eight milliseconds (~125 Hz). That's pretty zippy.

Let's look at the working code:

```

rgbmain      mov     bittimer, resettix
             add     bittimer, cnt
             waitcnt bittimer, #0

             mov     addr, hubpntr
             mov     nleds, ledcount

frameloop    rdlong  colorbits, addr
             add     addr, #4
    
```

At **rgbmain**, we copy *resettix* into *bittimer*, then synchronize the timer by adding the system counter (*cnt*) to it. The **waitcnt** instruction takes care of the reset timing. Boom! Easy! Next, we move the value in *hubpntr* (hub address of the color array) into *addr*. We move the number of LEDs in the string to *nleds*.

Now we're off! At **frameloop**, we read an RGB color value from the hub into *colorbits*. The hub address in *addr* is advanced to the next long by adding four.

The next section of code is not too hard, but does employ Tony's trick to swap the transmission order of the red and green bytes:

```

shiftout     ror     colorbits, #8
             mov     nbits, #24

:loop        test    nbits, #%111    wz
    
```

```

if_z         ror     colorbits, nbits
             ror     colorbits, #1    wc
if_c         mov     bittimer, bit1hi
if_nc        mov     bittimer, bit0hi
             or      outa, txmask
             add     bittimer, cnt
if_c         waitcnt bittimer, bit1lo
if_nc        waitcnt bittimer, bit0lo
             andn   outa, txmask
             waitcnt bittimer, #0
             djnz   nbits, #:loop
    
```

At the top, we're going to rotate to the right (**ror**) the value in color bits. Rotate differs from shift in that bits move from one end to the other (through the carry bit) – they're not lost to the *bit bucket*. With **ror**, bit0 will be rotated into bit31. In this case, we start out with \$00_RR_GG_BB and end up with \$BB_00_RR_GG (okay, how many geeks like me see BORG?).

I know what you're thinking ... "Hey, you said we have to shift out the green channel first!" You're right. We do, and we will. After setting the value of *nbits* to 24 (three bytes times eight bits per byte), we drop down the code at **:loop** which tests the value of *nbits*. What Tony came up with here is really clever. When *nbits* is 24, 16, or eight, we're going to rotate the value left (**rol**) by *nbits*. On our first time through, then, *nbits* will be 24 which will set the zero flag and cause the next line to run. This will modify the value from \$BB_00_RR_GG to \$GG_BB_00_RR. Note that we have the correct color element in the correct position for output.

The next line rotates the value by one to the left and captures the value of bit31 in the C flag. This flag is used to load the appropriate value into *bittimer*. After that, we start the bit by taking the TX line high. The C flag is used again to select a line to run **waitcnt**; you'll remember that the second parameter of **waitcnt** is the reload value. This structure lets us do the delay and reload the timer based on what's required for the low side of the bit.

At the end of the high period, the TX line is taken low and **waitcnt** runs the low-side timing. Finally, we check to see if there are any bits left to transmit. If there are, jump back to **:loop**.

Let me show how Tony's trick works to re-arrange the bytes for correct transmission output to the WS2812 color registers. On going in, we have

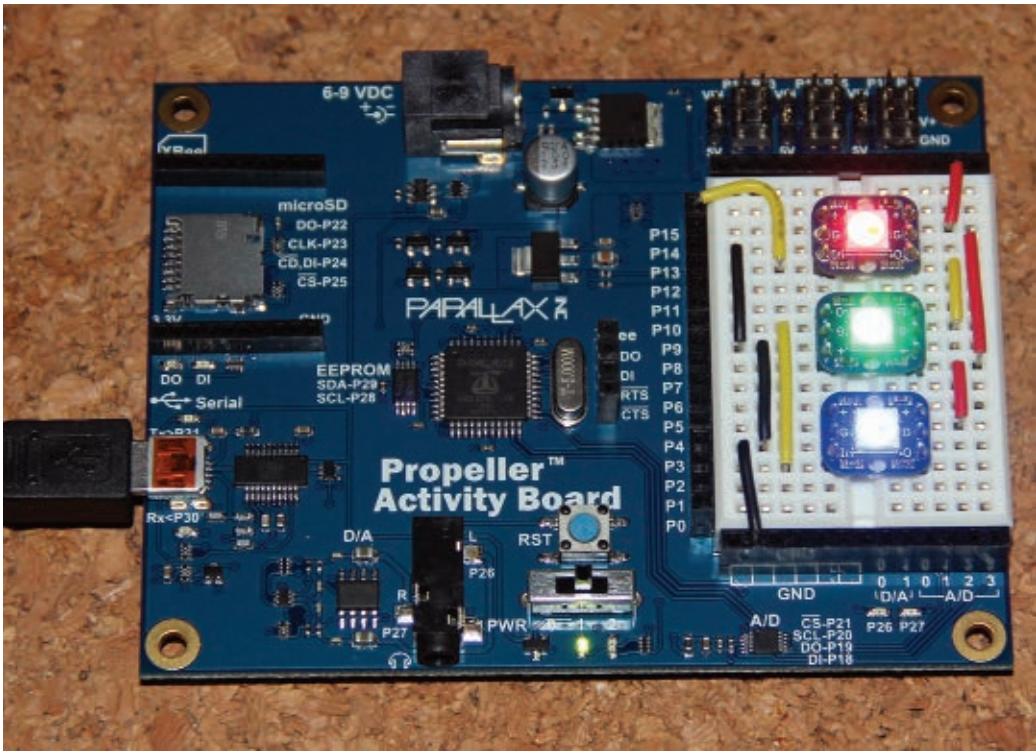

■ FIGURE 6. Running NeoPixels.

them in the human-friendly \$00_RR_GG_BB format. At the top of the loop, we prep the value by rotating it right by eight bits. This give us Captain Picard's mortal enemy: \$BB_00_RR_GG.

The loop looks for the current value in *nbits* to be 24, 16, or eight. The first time through, the loop *nbits* will be 24 so *colorbits* will be adjusted to \$GG_BB_00_RR. Transmitting the green byte will modify *colorbits* to \$BB_00_RR_GG. Now, *nbits* will be 16 so it gets adjusted again to \$RR_GG_BB_00. After transmitting the red bits, we'll have \$GG_BB_00_RR and *nbits* will be eight, causing a final adjustment to \$BB_00_RR_GG. In an interesting twist, *colorbits* ends up returning to its original value of \$00_RR_GG_BB at the end of the **shiftout** loop.

As I stated earlier, I tend to wear my Captain Obvioso costume when writing code — I don't employ many tricks unless really inspired. Tony's code is so devilishly clever that I had to use it. I think it's a great example of his creativity and brain power, and how a crafty programmer can take advantage of the Propeller's very powerful instruction set.

Let's finish up. At the end of the **shiftout** code, the channel count is decremented and the next channel data is read and sent. When we finish with channels, it's back to the top with a new reset period. Again, this code is set-and-forget. Once it's running, we don't have to do anything except manipulate the color values stored in the hub.

Light It Up!

Spin methods in the object make using this object very simple. We can, for example, use the **.set()** method with an RGB value to modify a channel, like this:

```
strip.set(0, $FF_00_00)
```

In this case, we'd be setting channel 0 to red at full brightness. At times, we may be animating the color channels, so there is a **.color()** method that will build the color component values:

```
strip.set(1, strip.color(red, green, blue))
```

This uses the variables *red*, *green*, and *blue* to build a color, then moves that to channel 1. Again, we don't have to do anything beyond setting a channel color as the driver cog will continuously update the LED string. Here's the code for the **.color()** method:

```
pub color(r, g, b)
    result.byte[2] := r
    result.byte[1] := b
    result.byte[0] := g
```

This takes advantage of the built-in **result** variable for

RESOURCES

Jon "JonnyMac" McPhalen
jon@jonmcp halen.com

Parallax, Inc.
www.parallax.com
Propeller chips and
programming tools

Adafruit Industries
www.adafruit.com
WS2812 LEDs
and modules

all methods, and uses the **.byte[]** modifier to move the color elements into **result** (which is returned to the caller).

While the low level driver code for the Arduino is of no use to us, the high level demonstration code can be. In most cases, it's very easy to translate C to Spin, and I found a few useful routines in the Adafruit WS2812 demo code (written by Phil Burgess of www.paintyourdragon.com). My favorite is a function called **wheel()**. Here's the Propeller translation:

```
pub wheel(pos)
    if (pos < 85)
        return strip.color(255-pos*3, pos*3, 0)
    elseif (pos < 170)
        pos -= 85
        return strip.color(0, 255-pos*3, pos*3)
    else
        pos -= 170
        return strip.color(pos*3, 0, 255-pos*3)
```

Wheel takes a value between 0 and 255 and returns a 24-bit color. From 0 to 84, it transitions from pure red (\$FF_00_00) to pure green (\$00_FF_00); from 85 to 169, it transitions from pure green to pure blue (\$00_00_FF); from 170 to 255, it transitions from pure blue back to pure red. Running **Wheel** in a loop creates a very soothing effect, and by using an LED-to-LED offset in the strip we can create a crawling rainbow effect. Give it a try. It's really nice.

One final note: I had no trouble running NeoPixels directly from the Propeller in an Activity Board (**Figure 6**), but the 3.3V output of the Propeller is technically below the V_{IH} level of the WS2812. If there's any distance between the Propeller and the WS2812, I suggest a TC4427 interface (refer again to the November 2012 column) or another buffer that will bump the 3.3V signal up to 5V. If you're designing a custom board, you could use a TinyLogic buffer from Fairchild to goose the signal.

Okay, that's it for this time. I know it was a little hairy going through all of that assembly code, but I hope you learned a trick or two and are inspired to write your own drivers. For those like me that enjoy lighting up Halloween, you have a new tool in the box to play with. So, go have some fun with it!

Until next time, keep spinning and winning with the Propeller! **NV**

Images Scientific Instruments Inc.

PIC Basic Project Board



16F88 PIC Basic Project Board Features

LCD Display - backlight & contrast control

2 A/D channels,

4 digital I/O lines

5V and 9V operation

Free Student version of PICBASIC PRO & Microcode Studio

Sensors:

Humidity

Temperature

Toxic Gas

Bend and Force Sensors

CdS Light sensors

Do More:

Frequency Meter

Pulse Generator

Elapse Timer

Radiation Pulse Counter

Volt Meter

www.imagesco.com/microcontroller/index.html

Save Up To 60% On Electronic Components

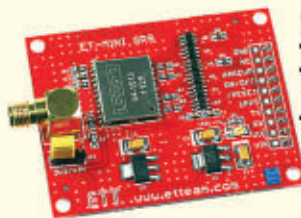

GPS Mini Board

- Ideal for Adding GPS to your System
- Connects Directly to Most Microcontrollers and Arduino Boards
- Position Accuracy to 2.5m

Only \$64.90

New 10A Solar Regulator

- High Performance Microcontroller Based PWM Regulator
- Suitable for both 12V and 24V Systems
- Works with Gel, Sealed and Standard Lead-Acid Batteries



Only \$19.90

PIC18F4550 Controller

- Powerful New Controller Board Based on the Microchip PIC18F4550
- Heaps of I/O including a USB Connection
- A/D, EEPROM, LED's and In-Circuit Programming



Only \$29.90

We are your one-stop shop for Microcontroller Boards, PCB Manufacture and Electronic Components

www.futurlec.com

DIY NEVER HAD A BETTER FRIEND...

Take your DIY project to the next level with PanaVise work holding tools. Perfect for hobbies, soldering, electronics, crafting & repair. PanaVise tools have hundreds of uses only limited by your imagination.

PanaVise, "better than a third hand!"



PANAVISE
Innovative Holding Solutions

Now available at



RadioShack



Model 301
640-0178



Model 324
640-0177

www.radioshack.com/StoreLocator



THE ORIGINAL SINCE 1994
PCB-POOL
Beta LAYOUT



FREE Stencil
with every prototype order



Embedded RFID

authenticate, track & protect your product

www.magic-pcb.com

Call Tyler: 1 707 447 7744
sales@pcb-pool.com

PCB-POOL® is a registered trademark of

www.pcb-pool.com

Beta

LAYOUT
create · electronics

Home Automation Telegesis Style

Go to www.nutsvolts.com/index.php?/magazine/article/september2013_DesignCycle for any additional files and/or downloads associated with this article. You can also discuss this topic at <http://forum.nutsvolts.com>.

These days, one would be hard pressed to find a household gadget that isn't in some way automated. Take a trip to your local home improvement store. You'll find that you can purchase a thermostat that plays on your household LAN and can be controlled from anywhere by way of your Android cell phone. Your garage door can be put under the control of another app residing in that same phone. If today's advanced embedded technology is applied accordingly, every appliance in your home down to the coffee maker has the opportunity to be remotely controlled and monitored. For those with deep pockets, home automation is just another purchase. For those with little to no technical savvy, home automation is out of reach. Well, at least it used to be. This month's discussion will revolve around a ZigBee-based home automation (HA) package offered by Telegesis. Absolutely zero ZigBee technical knowledge or a third mortgage is required to put the Telegesis home automation radios to work.

Telegesis HA 101

Even though the Telegesis HA solution is designed to be friendly to the nontechnical user, we will approach it from a technical point of view. This HA package consists of standard 802.15.4-based ZigBee radios that are loaded with a ZigBee PRO stack and custom firmware. The custom firmware is written to follow the ZigBee Home Automation Public Profile.

Access to the Telegesis ZigBee HA profile is provided by Hayes-like AT commands. The AT command set shields the user from the complexities of the ZigBee stack and exposes an easy to understand HA command interface.

The Telegesis solution is implemented using their ETRX357 ZigBee radio module. The custom ZigBee HA firmware comes in two flavors. The Combined Interface firmware runs on an ETRX357 module that is under the control of a mains powered device such as a PC.

Five-In-One firmware resides on ETRX357-hosted endpoints which can be battery powered.

The endpoint firmware has the ability to service multiple monitor and control functions using a single ETRX357 radio. Since there are five logical endpoints encapsulated in a single hardware endpoint, the firmware name Five-In-One is a logical choice.

In the lighting area, two of the five endpoints perform light on/off and light dimmer functions. Temperature and illuminance sensing in addition to an on/off switch function round out the five endpoints targeted by the Telegesis HA development kit. The five endpoints are accessed with commands that are transmitted by the Combined Interface device.

Five-In-One Nuts and Volts

The Five-In-One device is

■ **Photo 1.** This is an aerial view of the Five-In-One device that is part of the Telegesis HA development kit. The onboard temperature sensor, light sensor, buzzer, and LEDs can be accessed via the Combined Interface device.

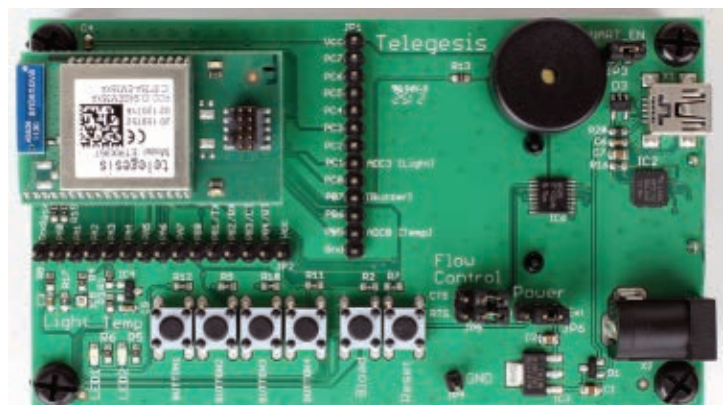

■ **Schematic 1.** This schematic is by no means complete. However, it provides enough information for us to understand how to manipulate the Five-In-One hardware.

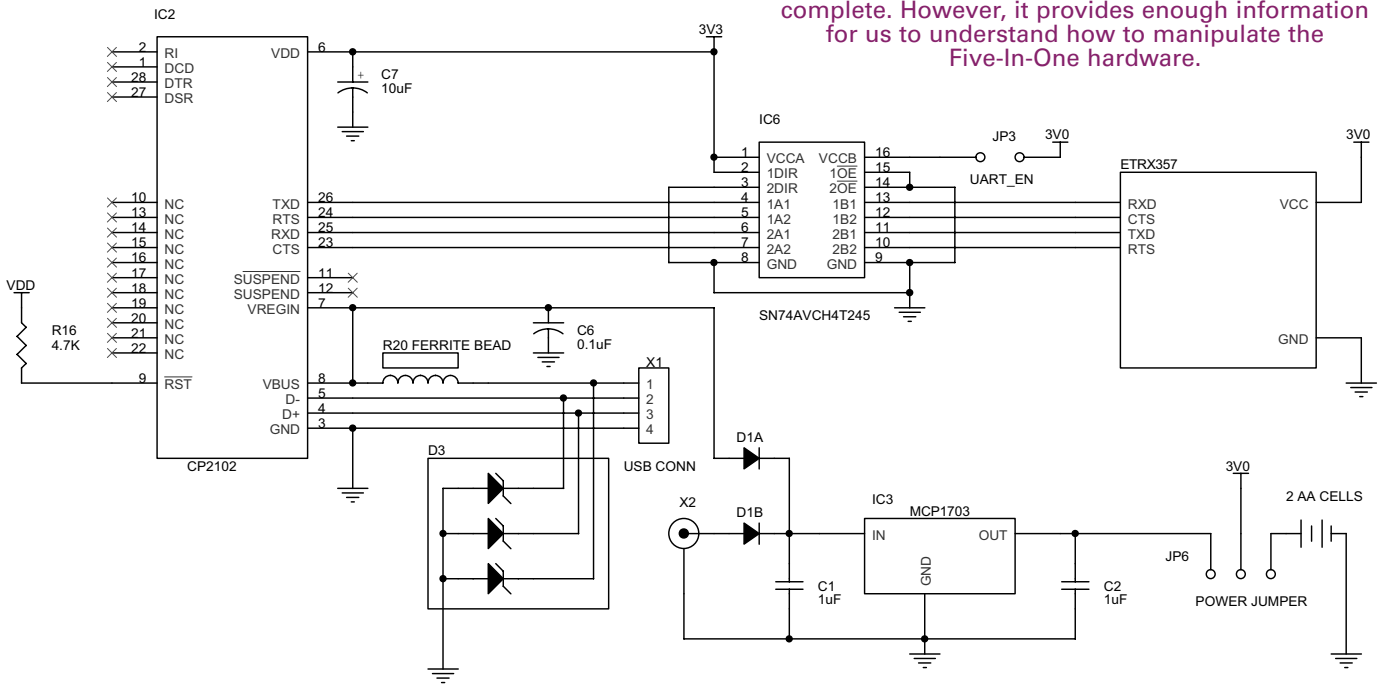

physically pictured in **Photo 1**. An official schematic of the Telegesis HA Five-In-One device was not included in the development kit documentation package. **Schematic 1** is unofficial and was created using magnified component observation, datasheet searches, and past experience. It is not important to identify exact component values since we are mainly interested in the blocks of hardware that make up the Five-In-One device.

The ETRX357 can be powered with a +3.3 volt power source. However, the endpoint design derived from the Five-In-One device will most likely be powered by a pair of household 1.5 volt batteries. To support this design point, the Five-In-One device sports a two-cell AA battery holder on the bottom side of its printed circuit board (PCB). The Five-In-One device can also be mains powered via a wall transformer.

If mains power is used, a Microchip MCP1703-30 LDO voltage regulator provides the +3.0 volt power rail for the development board's electronics. The MCP1703 also allows the Five-In-One device to take its power from the USB portal's +5.0 volt VBUS signal. Power from the USB portal and wall wart are ORed into the MCP1703 input pin by diode pair D1A and D1B. The +3.0 volt output of the MCP1703 or battery power is selected by placing a jumper on the appropriate pins of power pin block JP6.

A Silicon Labs CP2102 USB-to-UART bridge allows the Five-In-One to be connected to a PC for development purposes. With the inclusion of the CP2102, the Telegesis Terminal program can be used to issue Five-In-One AT commands to the ETRX357 via the virtual COM port formed by the CP2102's Windows driver. The Telegesis

Terminal program also provides a window that allows us to view the messages exchanged between the Combined Interface device and the Five-In-One device.

Since the final design would most likely not include a USB portal, the Five-In-One's CP2102 circuitry is based on a minimal component version of the standard CP2102 datasheet implementation. The CP2102's digital I/O signal levels follow the internal voltage regulator's +3.3 volt output voltage. The CP2102's internal voltage regulator is not capable of providing a +3.0 volt output. Thus, the CP2102 will by default feed the ETRX357's 3.0 volt I/O subsystem with 3.3 volt logic levels.

Although the ETRX357 datasheet does not discourage this, it doesn't condone it either. So, to be safe and to provide an accurate emulation of a battery-powered Five-In-One device, the CP2102's 3.3 volt logic levels will be converted to 3.0 volt logic levels at the ETRX357 interface.

The logic level conversion is easily performed using an SN74AVCH4T245 four-bit dual-supply bus transceiver. The configuration of the SN74AVCH4T245 is straightforward. The logic level of the quad of A ports follows the voltage applied to VCCA. The same goes for the B ports and their relationship to the voltage applied to VCCB. Note that the +3.3 volt output of the CP2102 is electrically connected to VCCA.

The +3.0 volt voltage rail is attached to VCCB through the UART_EN jumper. The CP2102's TXD, RXD, RTS, and CTS pins "see" a 3.3 volt logic level ETRX357. Conversely, the ETRX357 sees a 3.0 volt logic level CP2102.

Driving the 1DIR pin logically high moves data from the 1Ax portal to the 1Bx portal. Data direction on the 2Xx portal is determined by the logic level applied to the

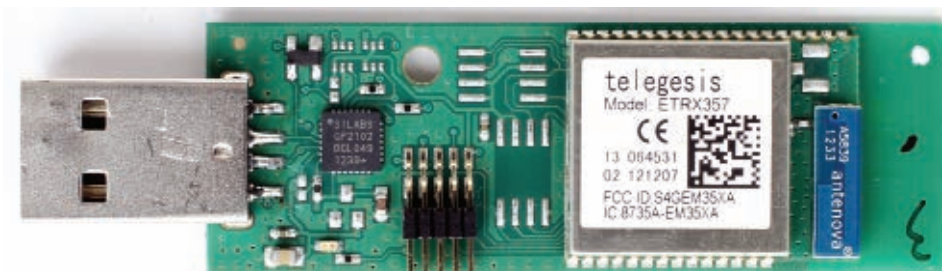

■ **Photo 2.** Your Combined Interface device comes as an enclosed dongle. I tore the covers off of mine to show you its innards. If you look closely, you can see the pry marks on the USB connector.

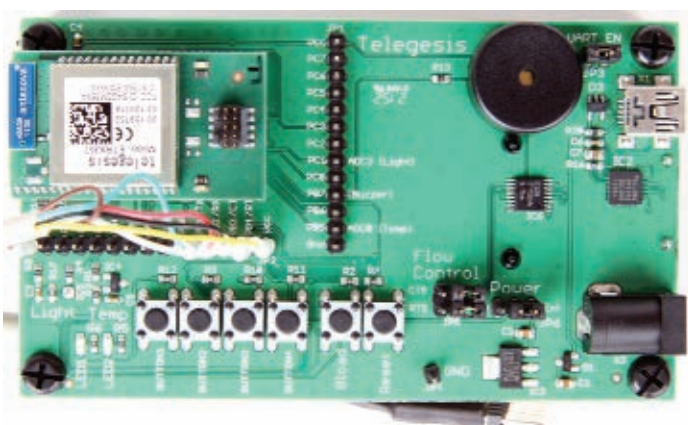

■ **Screenshot 1.** The Five-In-One can be completely exercised using the default command button set. In addition, the Telegesis Terminal can be used to verify the correct Telegesis HA AT command syntax.



■ **Photo 3.** The Five-In-One can be put into embedded debug mode by removing the power and UART_EN jumpers. ETRX357 power and signal connections are isolated to the male headers.

2DIR pin. In this case, 2DIR is tied logically low, forcing data to move from the 2Bx pins to the 2Ax pins. Pulling both OE (Output Enable) lines to ground assures that all 1Bx and 2Ax output pins are permanently enabled at their respective interfaces.

Removing the UART_EN jumper removes power from the VCCB pin which disables the B portal. Disabling the B port pins forces the B portal into a high impedance state allowing us to access the ETRX357 I/O pins directly with no interference from the disabled B portal.

Combined Interface Nuts and Volts

Looking at **Photo 2**, there's not a lot we can say about the Combined Interface device that you don't already know. Basically, we have the same minimal CP2102 installation, a user-accessible LED, and the ETRX357. The right-angle header is the ETRX357 programming portal. Note that the ETRX357 is powered solely from the CP2102's internal +3.3 volt regulator.

Now that you know what the Combined Interface device is made of, you don't have to tear the cover off of yours. If you plan to follow the base plan of this month's discussion, start prying around the USB connector.

Automating the Five-In-One

The idea behind the Telegesis HA development kit is

to allow the HA designer to easily model and test the Five-In-One and Combined Interface devices without reading any ZigBee manuals, writing any code, or building any hardware. It's rather obvious that the Five-In-One development kit hardware is ready for action out of the box. The software/firmware substitute isn't as obvious. Telegesis Terminal – which is a free download – provides the software application emulation. Telegesis Terminal is a PC application that allows the user to issue HA AT commands via preprogrammed buttons. The user also has the ability to easily create custom buttons.

A default Five-In-One Telegesis Terminal session is captured in **Screenshot 1**. The Telegesis Terminal's greatest contributions to the development process are instant AT command syntax verification and real time message display. The Five-In-One device can be used in the development process as a PC attached or embedded attached device. To use the Five-In-One with a PC, we will need to enable the CP2102 (UART_EN jumper in place) and enable the external power via the power jumper. The PC-enabled Five-In-One is shown back in **Photo 1**.

The Five-In-One you see in **Photo 3** is wire-ready to function as the target of an embedded host. To place the Five-In-One in **Photo 3** in embedded development mode, we must use the male headers to attach external power and signal. The signal interface to the CP2102 must be terminated by removing the UART_EN jumper.

Recall that removing the UART_EN jumper removes

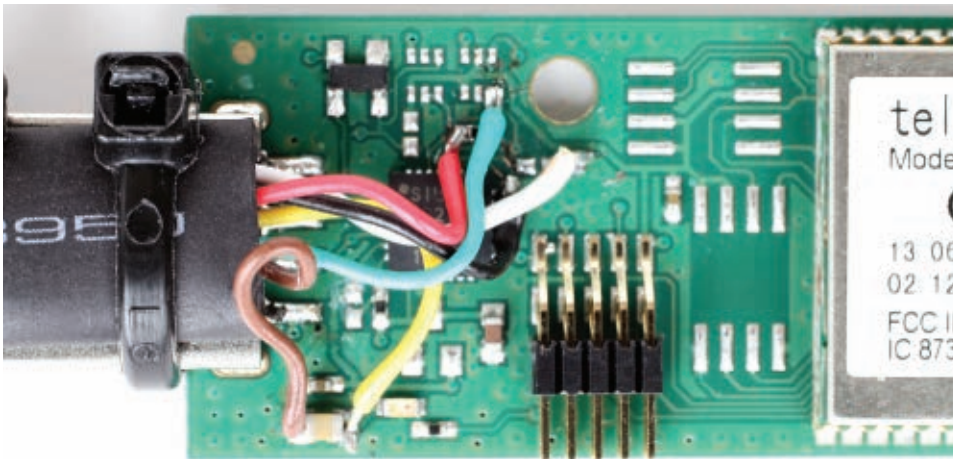

■ **Photo 4.** Note that I did not remove the CP2102. I simply “isolated” its signal and power pins. Once isolated, I tapped into the ETRX357’s signal and power via the isolated connections.



■ **Photo 5.** Here is the Combined Interface device after its embedded development mode modification. The Digilent six-pin connector cable is a female-to-female type. The Combined Interface device embedded interface must be male. The female-to-male conversion is done using an extended male header.

power to the four-bit dual-supply bus transceiver’s VCCB pin which disables the SN74AVCH4T245’s B portal. If the embedded host is not operating with 3.0 volt logic levels, the Five-In-One’s onboard power system must be isolated and disabled. This is easily done by removing the power jumper.

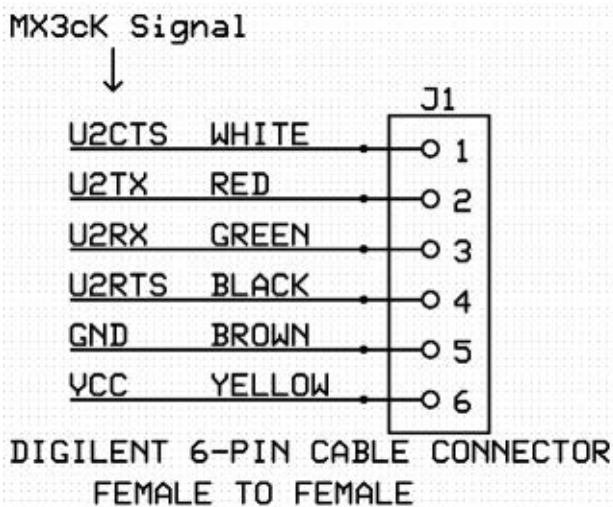

■ **Figure 1.** I sacrificed a Digilent six-pin cable connector to form the embedded host interface for our Combined Interface device.

With the power jumper absent, the output of the MCP1703 and the AA battery pack are removed electrically from the development kit circuitry. Power must be applied to the ETRX357 via the male headers. Embedded development mode allows us to attach a microcontroller host running at 3.3 volt logic levels. The ETRX357, light sensor, and temperature sensor are forced to adhere to the logic level and power rail of the host microcontroller. Telegesis Terminal cannot be used as a tool on the Five-In-One side of the connection when the Five-In-One is configured for embedded development mode.

Automating the Combined Interface

Preparing the Combined Interface device for PC use is a no-brainer. Simply plug the Combined Interface device into the host PC’s USB port. However,

rigging the Combined Interface device for embedded development requires a bit more work. Refer to **Photo 4** as I lay out the steps involved with preparing the Combined Interface device for embedded development mode.

The first order of business is to isolate the CP2102. The isolation of the CP2102 provides direct access to the ETRX357’s signal and power pins. Isolation of the CP2102 involves cutting the TXD, RXD, RTS, CTS, and power traces near the CP2102. At this point, the ETRX357 signal lines are no longer electrically connected to the CP2102. To avoid crazy things that happen to unused active components that remain powered, the CP2102’s power input was also isolated. So, now we have a CP2102 that has no power or signal connections, and an exposed ETRX357 signal interface.

Figure 1 represents the relationship between the Digilent six-pin connector cable and the embedded interface found on a Digilent Cerebot MX3cK microcontroller board. The layout shown in **Figure 1** has been applied to both the Five-In-One and Combined Interface device embedded development mode interfaces.

As you can see in **Photos 3** and **4**, I’ve either appropriately plugged or soldered the color-coded six-pin cable connector wires to realize the embedded Five-In-One and Combined Interface device interfaces,

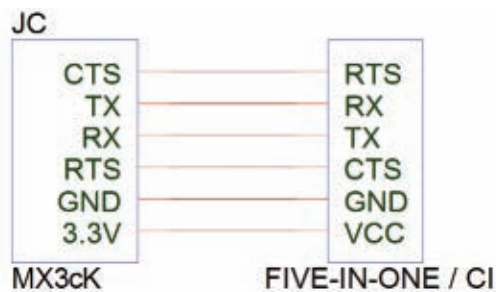

■ Figure 2. The JC port of the MX3cK is connected to the Five-In-One and Combined Interface device embedded interfaces in this manner. CTS is pin 1 of the JC connector.

respectively. The completed conversion of the Combined Interface device to embedded development mode is under the lights in **Photo 5**.

Shaking Down the Combined Interface Device

The embedded host of choice is the Cerebot MX3cK rendered in **Photo 6**. We are primarily interested in the MX3cK's JC interface as it contains the UART2 signals. Take another look at **Figure 1** for the pinout of the MX3cK's JC interface. Even though we are working with ZigBee HA hardware, the interfaces are simple RS-232 three-wire interfaces. The RTS and CTS pins are not supported by firmware on the MX3cK side. So, only the TX and RX signals are being driven in **Figure 2**, which is a null-modem circuit established between the MX3cK and the Combined Interface device.

To begin our shakedown, we will need some firmware targeting the MX3cK:

```
void sendATI(void)
{
    txBuf[0] = 0x0D; //preamble
    txBuf[1] = 0x0A; //preamble
    txBuf[2] = 'A'; //command
    txBuf[3] = 'T';
    txBuf[4] = 'I';
    txBuf[5] = 0x0D; //postamble
    txBuf[6] = 0x0A; //postamble

    xmitPkt(0x07);

    delaysms(1000);

    if(CharInQueue())
    {
        do{
            biteIn = rcvchar();
            printf("%c",biteIn);
        }while(CharInQueue());
    }
}
```

The ATI command will force the local ETRX357 to identify itself to the MX3cK. Every Telegesis HA AT

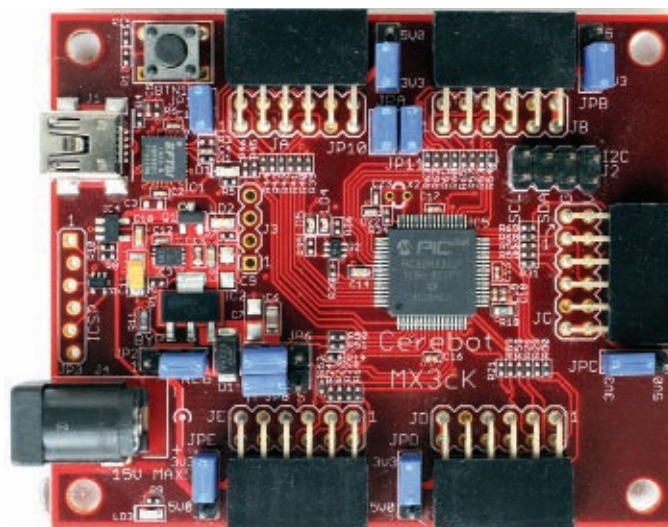

■ Photo 6. The Digilent Cerebot MX3cK is designed to interface to Digilent's line of Pmods. The Five-In-One and Combined Interface development mode devices both use MX3cK portal JC.

command begins and ends with a carriage return/line feed sequence. Our *sendATI* function will issue the ATI command, wait for one second, capture the ATI response, and display it. Behold **Screenshot 2**, which happens to contain that response we were waiting for. The serial input/output monitor application is part of the CCS C compiler. The MX3cK's UART1 is tied to the serial input/output monitor application via an onboard FTDI USB-to-UART bridge. The AT commands flow on the MX3cK's UART2. The modified Combined Interface device responded with the ZigBee radio type, the firmware type/revision, and its 64-bit EUI.

The next step is to command the Combined Interface to establish a network. Before we do that, we first need to make sure that the ETRX357 does not attempt to revive a previously established network. We do that with the disassociate local command and a familiar snippet of code:

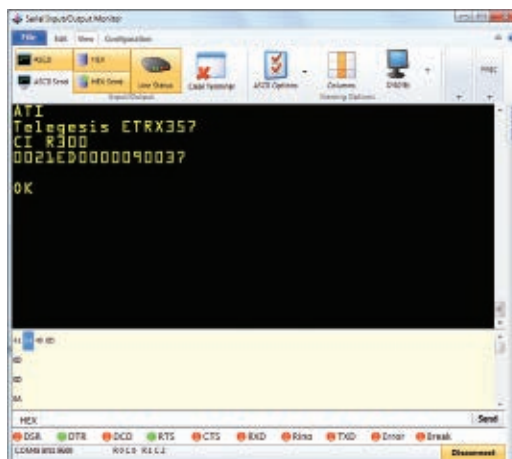

■ Screenshot 2. Success! This proves out the hardware and tells us we are on the right track with the firmware driver, as well.

```
void leaveNetwork(void)
{
    txBuf[0] = 0x0D; //preamble
    txBuf[1] = 0x0A; //preamble
    txBuf[2] = 'A'; //command
    txBuf[3] = 'T';
    txBuf[4] = '+';
    txBuf[5] = 'D';
    txBuf[6] = 'A';
    txBuf[7] = 'S';
    txBuf[8] = 'S';
    txBuf[9] = 'L';
    txBuf[10] = 0x0D; //postamble
    txBuf[11] = 0x0A; //postamble

    xmitPkt(12);

    delays(1000);

    if(CharInQueue())
    {
        do{
            biteIn = recvchar();
            printf("%c",biteIn);
        }while(CharInQueue());
    }
}
```

Screenshot 3 says it all. The Combined Interface device is blank as far as PAN establishment is concerned. The Combined Interface device does not belong to any particular PAN and it has not established a PAN to its knowledge. The Combined Interface artillery is primed to fire the establish network volley:

```
void formNetwork(void)
{
    txBuf[0] = 0x0D; //preamble
    txBuf[1] = 0x0A; //preamble
    txBuf[2] = 'A'; //command
    txBuf[3] = 'T';
    txBuf[4] = '+';
    txBuf[5] = 'E';
    txBuf[6] = 'N';
    txBuf[7] = ':';
```

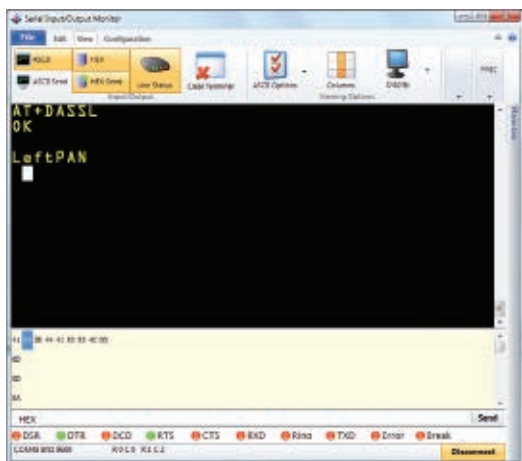

■ **Screenshot 3.** The OK is a signal that the local disassociate command completed successfully. The LeftPAN response is a signal to our firmware that we're ready to establish a new PAN.

```
txBuf[8] = '1'; //channel
txBuf[9] = '1';
txBuf[10] = ',';
txBuf[11] = '3'; //power
txBuf[12] = ',';
txBuf[13] = '2'; //PANID
txBuf[14] = '4';
txBuf[15] = '6';
txBuf[16] = '8';
txBuf[17] = 0x0D; //postamble
txBuf[18] = 0x0A; //postamble

xmitPkt(19); //send it

do{
    delays(1000);
}while(!CharInQueue());

if(CharInQueue())
{
    do{
        biteIn = recvchar();
        printf("%c",biteIn);
    }while(CharInQueue());
}
}
```

In structure, the *AT=EN:* command is no different than the previous AT commands we've issued. Along with the base establish network AT command, we can specify a desired channel, power level, and PANID. It may take up to 16 seconds to build the network. So, we'll mark time until network establishment response characters begin to flow into the UART2 receive buffer.

The ETRX357 is configured to echo the incoming command. We can see that in the top-most line of the network establishment response message captured in **Screenshot 4**. We have requested that the Combined Interface device build a PAN with a PANID of 2468 on channel 11 with a power factor of three. A success response follows, confirming the requested channel and PANID. The 64-bit EPANID is also revealed.

With the PAN established, the Combined Interface device is instructed to allow nodes to join the newly formed PAN:

```
void permitJoining(BYTE duration)
{
    txBuf[0] = 0x0D; //preamble
    txBuf[1] = 0x0A; //preamble
    txBuf[2] = 'A'; //command
    txBuf[3] = 'T';
    txBuf[4] = '+';
    txBuf[5] = 'P';
    txBuf[6] = 'J';
    txBuf[7] = 'O';
    txBuf[8] = 'I';
    txBuf[9] = 'N';
    txBuf[10] = ':';
    txBuf[11] = duration; //join window
    txBuf[11] = 0x0D; //postamble
    txBuf[13] = 0x0A; //postamble

    xmitPkt(14);
    delays(1000);
}
}
```

The *AT+PJOIN:* AT command can be issued without

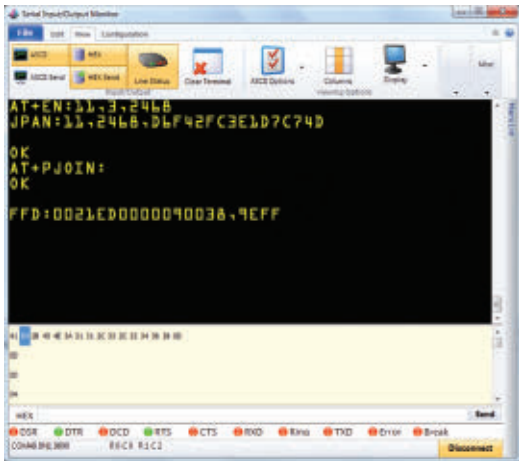

■ Screenshot 4. There is a lot of important information displayed here. The Combined Interface established a PAN with a PANID of 2468 on channel 11. A remote full function device joined the PAN and was assigned a device ID of 9EFF.

■ Screenshot 5. The Five-In-One device is running under the control of Telegesis Terminal. Once the Combined Interface embedded device allowed joining, the Five-In-One device accepted the invitation to join PAN 2468.

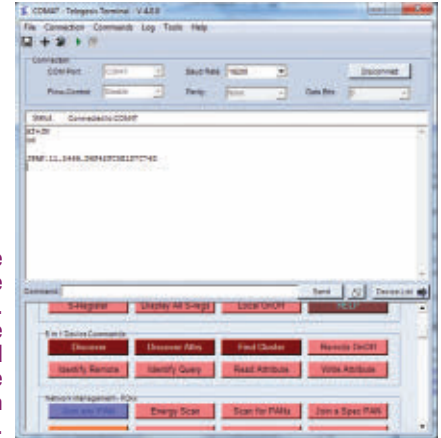

the *join window* timeout parameter. When not specified, the default join timeout is 60 seconds. I decided to include the optional parameter in our command sequence:

```
int main (void)
{
    init();
    sendATI();
    //send ATI
    leaveNetwork();
    //send AT+DASSL
    formNetwork();
    //send AT+EN:11,3,2468
    permitJoining(0x42);
    //send AT=PJOIN:0x42
    do{
        //wait for and display incoming
        //characters
        if(CharInQueue())
        {
            biteIn = recvchar();
            printf("%c",biteIn);
        }
    }while(1);
}
```

As you can see, our join timeout is set for 66 seconds.

As the join timeout clock is ticking, I reached over and clicked on the *Join any PAN* button on the Telegesis Terminal console attached to the Five-In-One device. The AT+JN command was issued to the Five-In-One device which scanned the ether and found a PAN on channel 11 with a PANID of 2468. Since it can join any PAN and PAN 2468 is the only one available, communications with the Combined Interface device were established. **Screenshot 5** details the Five-In-One side of the conversation.

The final line of the Combined Interface device response in **Screenshot 4** acknowledges the acceptance of the Five-In-One device into the PAN. The Five-In-One device has identified itself as a full function device and exposed its 64-bit EUI. The Combined Interface device assigned the Five-In-One device an ID of 9EFF, which is verified by the Five-In-One device.

Boom! Boom! Out Go the Lights

All of the Telegesis HA AT commands are issued exactly like we have witnessed. So, all that's left now is to control some lighting, check some temperatures, and add Telegesis home automation development to your design cycle. **NV**

RF Specialists

Affordable RF Modules

Introducing the LMX-ISM-242-SR and LMX-ISM-242-LR



Data Loggers

Stand Alone and Wireless Mesh Networking Logger



Industrial Bluetooth

OEM, Modules, Wireless Device Servers, RS-232 Long range options, low cost



ZigBee Pro

OEM Modules and USB ZigBee Sticks, Mesh Networks



Low Power, High Performance Semiconductors

Excellent Sensitivity, Very Efficient Power Amplifiers

Narrow Band, General Purpose, TSSOP, RF Microcontrollers
Typical Sensitivities are in the range of -110dBm to -126 dBm for 1.2 kbps

RF Design Services

Prepared to work with your in-house engineers, or support your RF project from initial design to implementation.

Industrial • Military • Space • Medical • Smart Grid Metering • SCADA • Lighting Control



LE MOS

INTERNATIONAL

www.lemosint.com
866.345.3667
sales@lemosint.com

"Making your RF ideas into profitable products."

For complete product details, visit our webstore!!

The Nuts & Volts **WEBSTORE**

GREAT FOR DIYers!

Getting Started with chipKIT by Chuck Hellebuyc

In this book, Chuck Hellebuyc — who has authored many entry level technical books — shows you how to get started with the chipKIT Uno32 using some very simple example sketches (sketches are a software program in the Arduino world) that demonstrate how to use digital inputs, digital outputs, analog inputs, and analog outputs. These are the fundamental building blocks every electronic project needs. With the examples in this book, you'll have what you need to get your electronic project up and running.



\$19.95

Practical Electronics for Inventors, Third Edition by Paul Scherz, Simon Monk

The electronics know-how you need to become a successful inventor.

Spark your creativity and gain the electronics skills required to transform your innovative ideas into functioning gadgets. This hands-on updated guide outlines electrical principles and provides thorough easy-to-follow instructions, schematics, and illustrations.

\$29.95

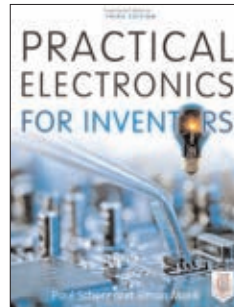

NEW! 30 Arduino Projects for the Evil Genius: Second Edition by Simon Monk

Fully updated throughout, this do-it-yourself guide shows you how to program and build fascinating projects with the Arduino Uno and Leonardo boards, and the Arduino 1.0 development environment. *30 Arduino Projects for the Evil Genius, Second Edition*, gets you started right away with the simplified C programming you need to know, and demonstrates how to take advantage of the latest Arduino capabilities.

\$19.95



Build Your Own Transistor Radios by Ronald Quan A Hobbyist's Guide to High Performance and Low-Powered Radio Circuits

Create sophisticated transistor radios that are inexpensive yet highly efficient. Inside this book, it offers complete projects with detailed schematics and insights on how the radios were designed. Learn how to choose components, construct the different types of radios, and troubleshoot your work.

*Paperback, 496 pages
\$49.95



Build Your Own Electronics Workshop by Thomas Petruzzellis

BUILD YOUR OWN DREAM ELECTRONICS LAB!

This value-packed resource provides everything needed to put together a fully functioning home electronics workshop! From finding space to stocking it with components to putting the shop into action — building, testing, and troubleshooting systems. This great book has it all! And the best part is, it shows you how to build many pieces of equipment yourself and save money, big time!

Reg Price \$29.95
Sale Price \$26.95



Beginner's Guide to ... Programming the PIC24/dsPIC33 by Thomas Kibalo

Kibalo takes you step by step through the fundamentals of programming the PIC24H which can equally be applied to the dsPIC33.

His clear explanation of the inner workings make learning the PIC24H/dsPIC33

16-bit architecture easy. His code examples demonstrate how to perform the functions most applications require. The hardware is shown in a simple breadboard setup so even a beginner can build it, along with very few extra components needed.

\$39.95*



How to Diagnose and Fix Everything Electronic by Michael Jay Geier

Master the Art of Electronics Repair

In this hands-on guide, a lifelong electronics repair guru shares his tested techniques and invaluable insights. *How to Diagnose and Fix Everything*

Electronic shows you how to repair and extend the life of all kinds of solid-state devices, from modern digital gadgetry to cherished analog products of yesteryear.

\$24.95



Programming PICs in Basic by Chuck Hellebuyc

If you wanted to learn how to program microcontrollers, then you've found the right book! Microchip PIC microcontrollers are being designed into electronics throughout the world and none is more popular than the eight-pin version. Now the home hobbyist can create projects with these little microcontrollers using a low cost development tool called the CHIPAXE system and the Basic software language. Chuck Hellebuyc introduces how to use this development setup to build useful projects with an eight-pin PIC12F683 microcontroller. **\$14.95**



Master and Command C for PIC MCUs by Fred Eady

Master and Command C for PIC MCU, Volume 1 aims to help readers get the most out of the Custom Computer Services C compiler for PIC microcontrollers.

The author describes some basic compiler operations that will help programmers particularly those new to the craft create solid code that lends itself to easy debugging and testing. As Eady notes in his preface, a single built-in CCS compiler call (`output_bit`) can serve as a basic aid to let programmers know about the "health" of their PIC code.

\$14.95



Order online @ www.store.nutsvolts.com
 Or CALL 1-800-783-4624 today!

BOOK & KIT COMBOS

16-Bit Complete Combo

Combo Price \$319.95
 For complete details visit our webstore @ www.nutsvolts.com

Beginner's Guide Complete Combo!

Combo Price \$229.95
 For complete details, visit our webstore @ www.nutsvolts.com

Arduino Handheld Prototyper System

Arduino Proto Shield \$16.99
I2C Mini Terminal \$29.99
Handheld Base \$13.99
All three*: \$59.99
 *Arduino and battery not included
From Smiley's Workshop

CD-ROM SPECIAL

**Nuts & Volts
 9 CD-ROMs
 & Hat Special!**
 That's 108 issues.
 Complete with supporting code and media files.

Free Shipping!
Only \$189.95
 or \$24.95 each.

The Nuts & Volts Pocket Ref
 All the info you need at your fingertips!
 This great little book is a concise all-purpose reference featuring hundreds of tables, maps, formulas, constants & conversions. AND it still fits in your shirt pocket!

Only \$12.95
 Visit <http://store.nutsvolts.com> or call (800) 783-4624

CALL 1-800-783-4624 today!
Order online @ www.nutsvolts.com

PROJECTS

Geiger Counter Kit

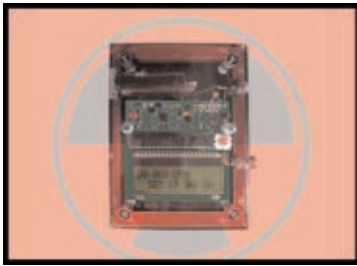

This kit is a great project for high school and university students. The unit detects and displays levels of radiation, and can detect and display dosage levels as low as one micro-roentgen/hr. The LND712 tube in our kit is capable of measuring alpha, beta, and gamma particles.

Subscriber's Price \$145.95
Non-Subscriber's Price \$148.95

3D LED Cube Kit

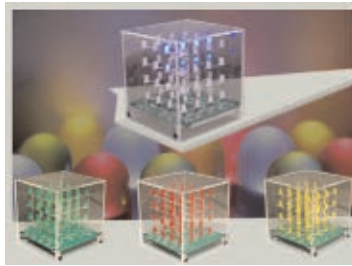

This kit shows you how to build a really cool 3D cube with a 4 x 4 x 4 monochromatic LED matrix which has a total of 64 LEDs. The preprogrammed microcontroller that includes 29 patterns that will automatically play with a runtime of approximately 6-1/2 minutes. Colors available: Green, Red, Yellow & Blue

Subscriber's Price \$57.95
Non-Subscriber's Price \$59.95

Radiation Monitor Alarm Kit



This is an inexpensive surface-mount project that is good for beginners to start with. This kit has its own printed circuit board (PCB) which makes mounting the components easy. Plus, it comes in a pocket size shielded aluminum case measuring 3.5" in length and 1" in diameter. The on-off switch is a pushbutton on the bottom.

Subscriber's Price \$32.45
Non-Subscriber's Price \$33.95

Neon Transistor Clock Kit

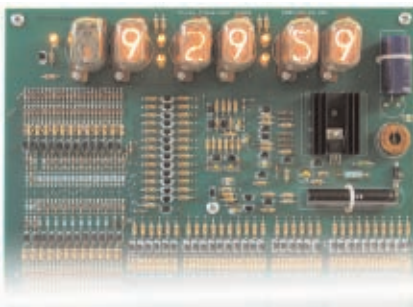

Add HIGH VOLTAGE to your clock!
 This is a Nixie Tube display version of the Transistor Clock. It uses only discrete components — no integrated circuits. For more info, see the April 2012 issue.

Subscriber's Price \$245.95
Non-Subscriber's Price \$249.95

Seismograph Kit

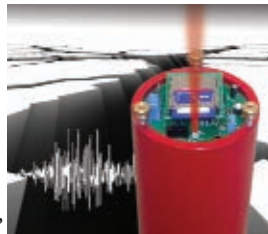

As seen in the May 2012 issue. Now you can record your own shaking, rattling, and rolling.

The Poor Man's Seismograph is a great project /device to record any movement in an area where you normally shouldn't have any. The kit includes everything needed to build the seismograph. All you need is your PC, SD card, and to download the free software to view the seismic event graph.

Subscriber's Price \$79.95
Non-Subscriber's Price \$84.95

Magic Box Kit



As seen in the November 2011 issue. Battery Marvel helps protect cars, trucks, motorcycles, boats, and any other 12V vehicles from sudden battery failure. This easy-to-build kit features a single LED that glows green, yellow, or red, indicating battery health at a glance. An extra-loud piezo driver alerts you to any problems.

Details, please visit our website.

Subscriber's Price \$18.95
Non-Subscriber's Price \$19.95

FOR BEGINNER GEEKS!



\$59.95

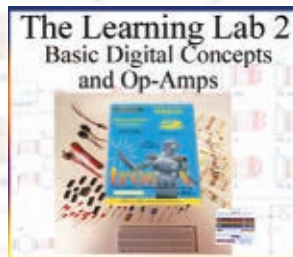

\$49.95

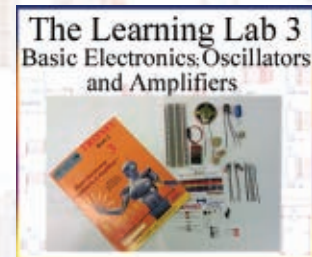

\$39.95

The labs in this series — from GSS Tech Ed — show simple and interesting experiments and lessons, all done on a solderless circuit board.

As you do each experiment, you learn how basic components work in a circuit, and continue to build your arsenal of knowledge with each successive experiment.

For more info and a promotional video, please visit our webstore.

ELECTRONET

GET THE NUTS&VOLTS DISCOUNT!
Mention or enter coupon code **NVRM212** and receive 10% off your order!

ramsey
www.ramseykits.com
AM/FM Broadcasters • Hobby Kits
Learning Kits • Test Equipment
...AND LOTS OF NEAT STUFF!

www.canakit.com

- Over 200 Kits & Modules to choose from!
- Easy Worldwide Online Ordering
- Fast Delivery & Same Day Shipping

FM Transmitters • Timers • Audio Amplifiers • Motor Controllers

THE ORIGINAL SINCE 1994
PCB-POOL
Beta LAYOUT

- Low Cost PCB prototypes
- Free laser SMT stencil with all Proto orders

www.pcb-pool.com

Serial LCD & LED
www.melabs.com

Got electronics?
www.nutsvolts.com

ALL ELECTRONICS CORPORATION
Electronic Parts & Supplies Since 1967

For the ElectroNet online, go to **www.nutsvolts.com** click **Electro-Net**

INVEST in your BOT!

INVEST in **HiTEC**

12115 Paine Street • Poway, CA 92064 • 858-748-6948 • www.hitecrod.com

d6 LABS

Official US Distributor for **HopeRF** Modules
www.d6labs.com

RF Modules ■ Antennas ■ Connectors

USB Add USB to your next project-- It's easier than you might think!

DLP Design

USB-FIFO • USB-UART • USB/Microcontroller Boards
RFID Readers • Design/Manufacturing Services Available
Absolutely NO driver software development required!
www.dlpdesign.com

superbrightleds.com

COMPONENT LEDs • LED BULBS • LED ACCENT LIGHTS

Aztec
MCU Prototyping

PICAXE and Arduino design and development tools
www.aztecmcu.com

FREE PCB Design Software

Get Started Now at **FabStream.com**

FabStream
A DownStream Technologies Solution

Karlsson Robotics

For all your Modules, Components, Adapters, Custom Design and Prototyping needs.

www.karlssonrobotics.com

CORIDIUM

ARM controllers running floating point **BASIC** from \$10.00
www.coridium.us

Pololu
Robotics & Electronics
WWW.POLOLU.COM

Motor Controllers • Arduino • Signal Generators • FM Transmitters • Timers • Audio Amplifiers

200 KHz Function Generator



\$49.95
ASSEMBLED

UK307

4-Port USB Relay Controller with 6-Channel Analog/Digital Interface

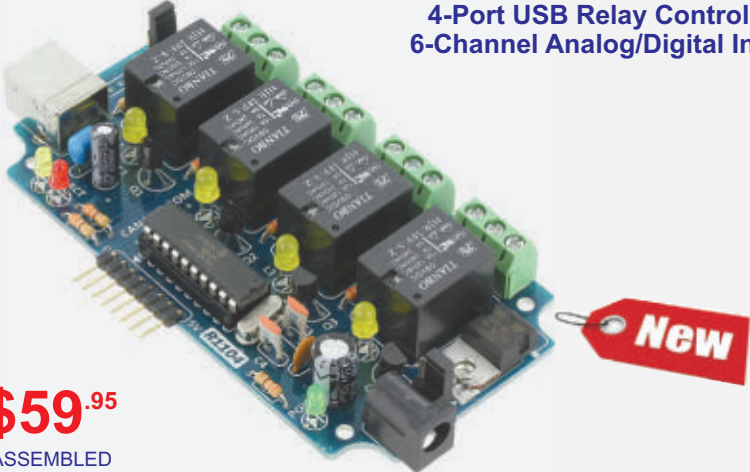

\$59.95
ASSEMBLED

UK1104

5A Motor Speed Controller (PWM)



\$22.95
ASSEMBLED

UK1102

Stereo Audio Amplifier (10W)



\$35.95
ASSEMBLED

UK560

Plug-In Breadboard Power Supply



\$19.95
ASSEMBLED

UK277

7A Bi-Directional Motor Speed Controller (PWM)



\$39.95
ASSEMBLED

UK1125

USB PIC Programmer (MPLAB Compatible)



\$69.95
ASSEMBLED

UK1300

Digital LED Timer (Up/Down)



\$46.95
ASSEMBLED

UK258

* Limit one per customer. Can not be combined with other coupons or volume discounts. Does not apply to products already on sale. Prices subject to change without notice.

Arduino Handheld Prototyper

Part 3 Fresh Air Controller

Last month, we continued our series on an Arduino handheld prototyper that — as the name implies — lets us develop prototypes that are portable in our very own hand. I'll admit it. I've been having too much fun with this prototyper. This thing lets me do Arduino development using a PC (as usual) but also lets me get input from pushbutton keys, plus produce visual output on an LCD — all in a compact portable framework. Gone are the days of having the bits and pieces scattered around on a table, hooked up to a PC. Now, I can just grab the whole thing and take off.



■ FIGURE 1: Castles have courtyards.

Fresh Air Controller for a Castle

I was in the midst of developing the handheld prototyper when a friend who lives nearby asked me to help him use an Arduino to develop a fresh air controller for his castle. (Well, it's certainly close enough for these parts.) It's got a courtyard (**Figure 1**), a great room, suits of armor, a broadsword next to a fireplace you could roast a dragon in, plus gargoyles (**Figure 2**). Joel Fairstein owns this particular castle and does some outstanding tinkering, so he decided to do a project to help heat and cool his place. This is a perfect application for our handheld prototyper — even if you don't own a castle.



■ FIGURE 2: What's a castle without gargoyles?

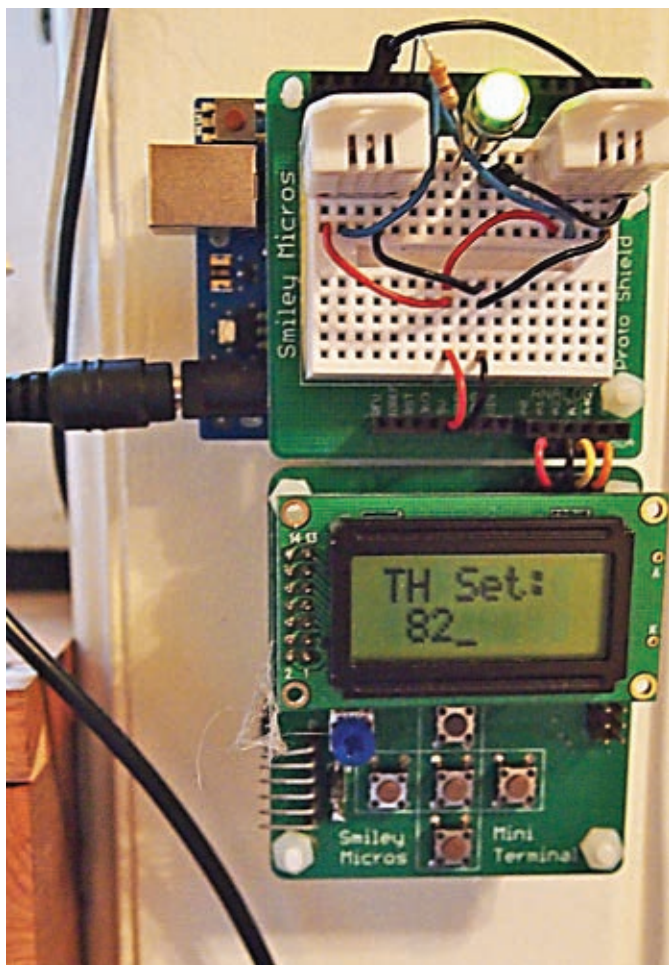

■ FIGURE 3: Fresh air controller prototype.



■ FIGURE 4: Inside view of a vent box and the controller.



■ FIGURE 5: Outside view of a vent box.

Figure 3 shows the prototyper set up as a fresh air controller; Figures 4 and 5 show the vent boxes Joel designed that have an aerodynamic vane that gently opens when the attic fan turns on, then closes to keep out the rain when the attic fan shuts off. Of course, they have a bug screen to keep out the critters at all times.

These vent boxes are easily removable for those times of the year when it is just too hot or cold outside to warrant using this system.

The fresh air controller relies on us having accurate measures of indoor and outdoor temperatures and humidity, so we'll know when to turn the attic fan on and off. Let's look at measuring these parameters and the sensor we will be using.

Sensing Temperature and Humidity

Relative Humidity

Humidity tends to be important to our comfort. You

can feel cooler in Death Valley at 105° than you might feel in a Louisiana swamp at 85°. The reason is that we sweat to cool off. For sweat to work, it has to evaporate. If the air is dry, it can evaporate quickly; if the air is very humid, it might not evaporate at all.

To use a modest simplification: The amount of water vapor that air can hold depends on the air temperature. Warmer air can hold more water vapor than cooler air. This is why it tends to rain when a warm front with a lot of moisture runs into a cold front. The warm air cools down and the water vapor condenses into liquid that drops out of the sky.

We use the term RH (Relative Humidity) to mean the amount of water vapor (humidity) that may be present at a given temperature before the air becomes saturated and water begins to turn to liquid — the dew point.

An RH of 100% means that the air is saturated, while 0% means there is no water vapor present. People tend to be most comfortable at an RH between 30% and 70%.

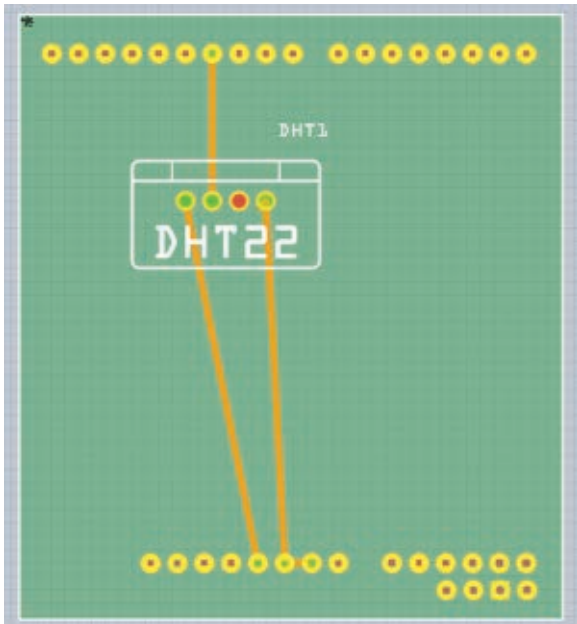

■ FIGURE 8: Fritzing PCB view.

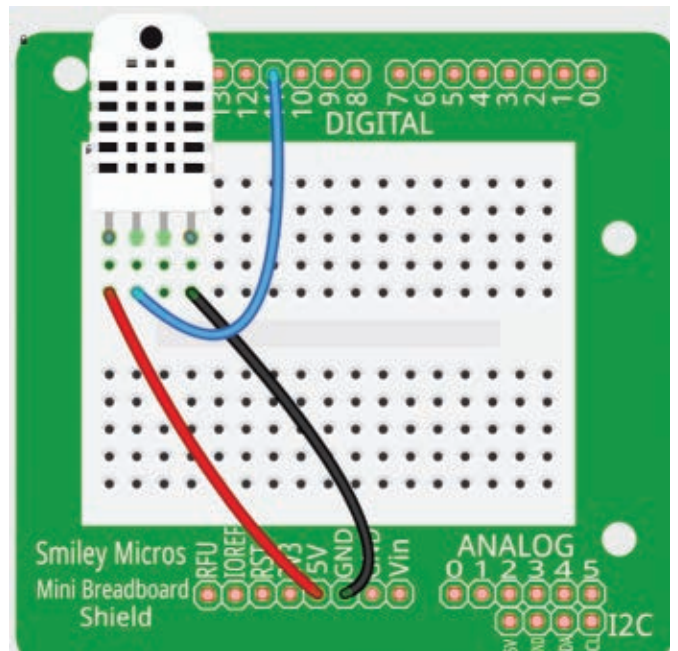

■ FIGURE 6: Fritzing breadboard view.

Measuring RH

In order to measure RH, we need to not only sense the water vapor pressure but we need to sense the temperature, as well. There are many ways to do this, but the most common inexpensive way this is done is with sensors such as the DHT22 (Figure 6) that outputs a digital signal that we can read for the RH and temperature. In practice, we can read this sensor about once every two seconds and expect to get an RH reading that is $\pm 1\%$ accurate. The digital signal output is somewhat arcane, but fortunately we have access to pre-built and tested libraries to use with the Arduino.

Temperature

Temperature is a measure of how hot or cold an object is; we measure temperature with a thermometer (duh). The DHT22 uses a thermistor (thermal resistor) which is a type of resistor that has a resistance that varies significantly with temperature. As with the RH, the temperature is reported as part of the digital data output of the DHT22. The temperature reading is accurate to ± 0.36 Fahrenheit.

Using the DHT22 Hardware

There are lots of ways to sense temperature and humidity. We will use the DHT22 [you can get one from

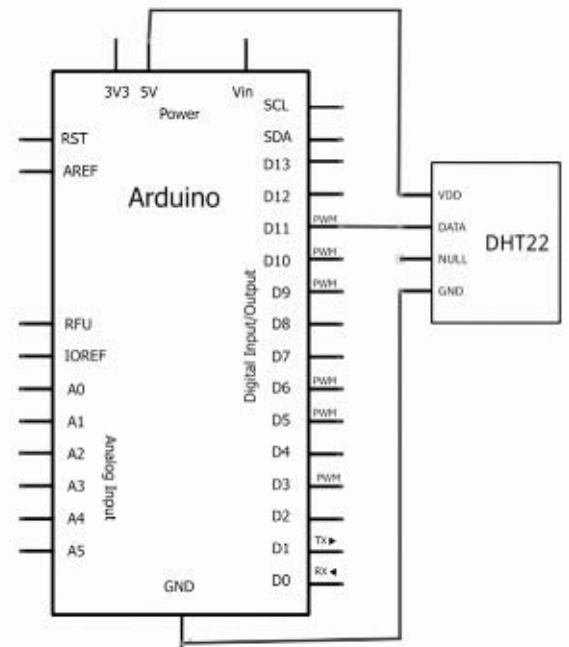

■ FIGURE 7: Fritzing schematic view.

Adafruit or Virtuabotix for about \$13]. This sensor is a bit more expensive than its DHT11 little brother, but it is also more precise, accurate, and has a better range for temperature/humidity.

It is absolutely critical that you pay attention here because you can very easily kill your \$13 DHT22 if you wire it wrong.

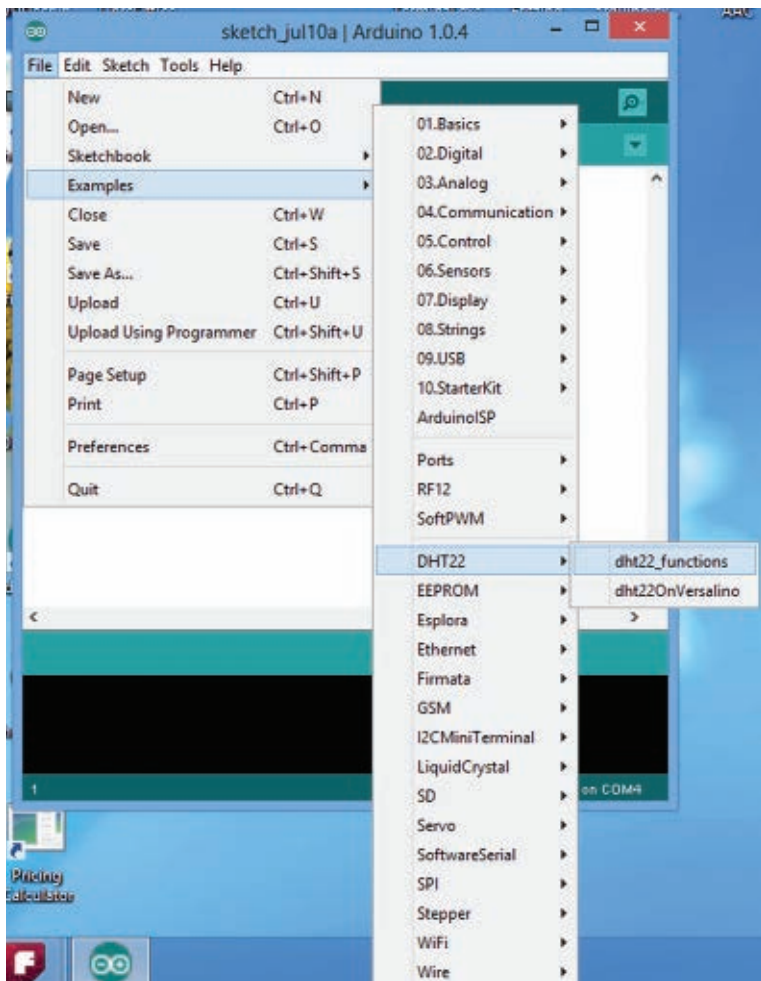

■ FIGURE 9: Open the DHT22 example.

Design for DHT22 With Fritzing

Let's look at how to use Fritzing to design a circuit with the DHT22 on the Arduino proto shield. You can refer to my blog at <http://blog.smileymicros.com/> to see how to do this. You can get the Fritzing component for the DHT22 from <http://learn.adafruit.com/using-the-adafruit-library-with-fritzing/download-the-fritzing-library-from-github>. Sorry about the long URL, but Adafruit is a good place to get the DHT22. They also have their own Arduino library for this part. However, we will use the aforementioned Virtuabotix library (it worked better for me) since you can also get a DHT22 there.

We see the Fritzing component in the breadboard view in **Figure 6**; the schematic view in **Figure 7**; and the printed circuit board (PCB) view in **Figure 8**. Note very carefully how this is wired. Make sure that you don't miswire this device because (as mentioned) you can kill it if you do. The Adafruit tutorial recommends a 10K pull-up on the data line, but I found it was not needed in this application.

Test It With the Arduino

As mentioned, we will use the DHT22 Arduino library written by Joseph Dattilo of Virtuabotix (another good reason to buy your DHT22 from them). The link to get this code is www.virtuabotix.com/core-content/uploads/2012/09/DHT22_1S0A.zip.

Since this is GPL, I've included it in the FreshAirController.zip download that you can get from the article link.

To use this library, unzip the DHT22_1S0A.zip file and then copy the DHT22 directory to your Arduino libraries directory. In my case, this was C:\Arduino-1.0.4\libraries. If you have the Arduino integrated development environment (IDE) open, you will need to close it and reopen it so that it will find the library.

The Virtuabotix library has some examples that we can use to test this design. Open the Arduino IDE, then in the File menu item click on the Examples\DHT22\dht22_functions as shown in **Figure 9**.

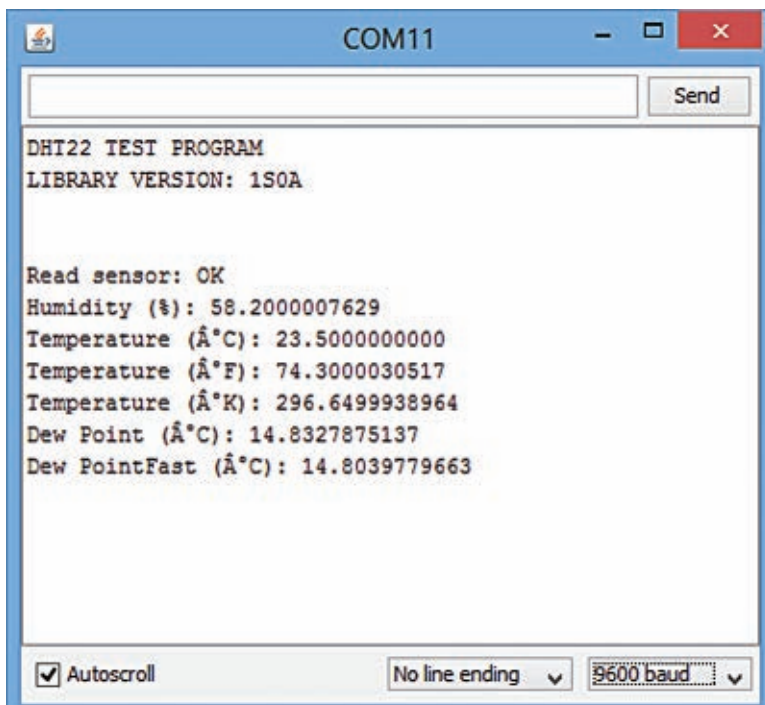

■ FIGURE 10: DHT22 example.

■ FIGURE 11: Two DHT22s breadboard view.

You can see in the code the various steps required to use the sensor. Add the following to your *include* list:

```
#include <dht22.h>
```

Next, you'll need to create an instance of the *class* library as follows:

```
dht22 DHT22;
```

We have physically attached the DHT22 sensors to pin 11, so you will need to change the following in the example setup function. Change this:

```
DHT22.attach(2);
```

to this:

```
DHT22.attach(11);
```

Reading the Sensors

We read the sensor as follows:

```
int chk = DHT22.read();
```

Reading the sensor returns a value indicating the status of the read which you may check with the following:

```
switch (chk)
{
  case 0: Serial.println("OK"); break;
  case -1: Serial.println("Checksum error"); break;
  case -2: Serial.println("Time out error"); break;
  default: Serial.println("Unknown error"); break;
}
```

You will want to design your own code to respond to these conditions since you only want to use those values from a read that reports "OK."

In the example code, we see several ways to acquire the data that was read, and report it to the serial port:

```
Serial.print("Humidity (%): ");
Serial.println((float)DHT22.humidity, DEC);

Serial.print("Temperature (°C): ");
Serial.println((float)DHT22.temperature, DEC);
```

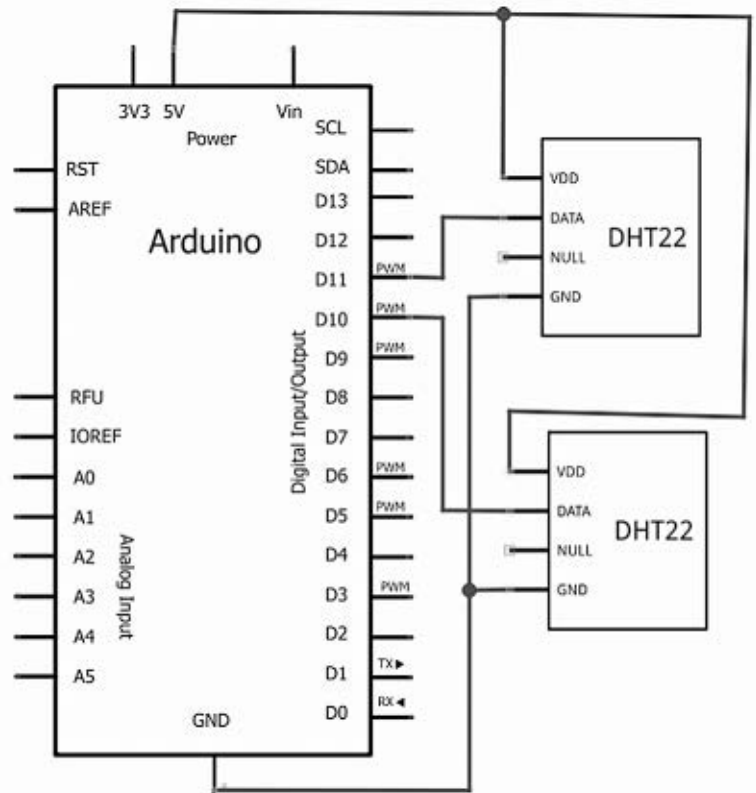
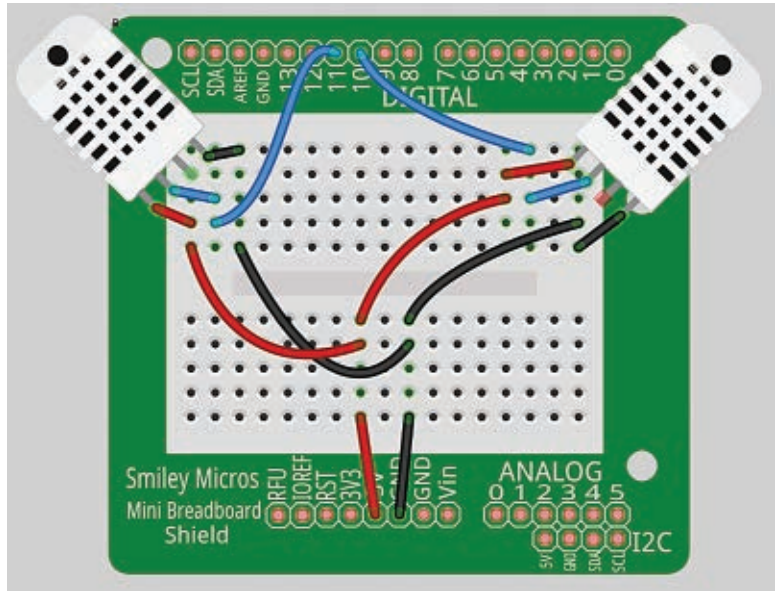

■ FIGURE 12: Two DHT22s schematic view.

```
Serial.print("Temperature (°F): ");
Serial.println(DHT22.fahrenheit(), DEC);

Serial.print("Temperature (°K): ");
Serial.println(DHT22.kelvin(), DEC);
```

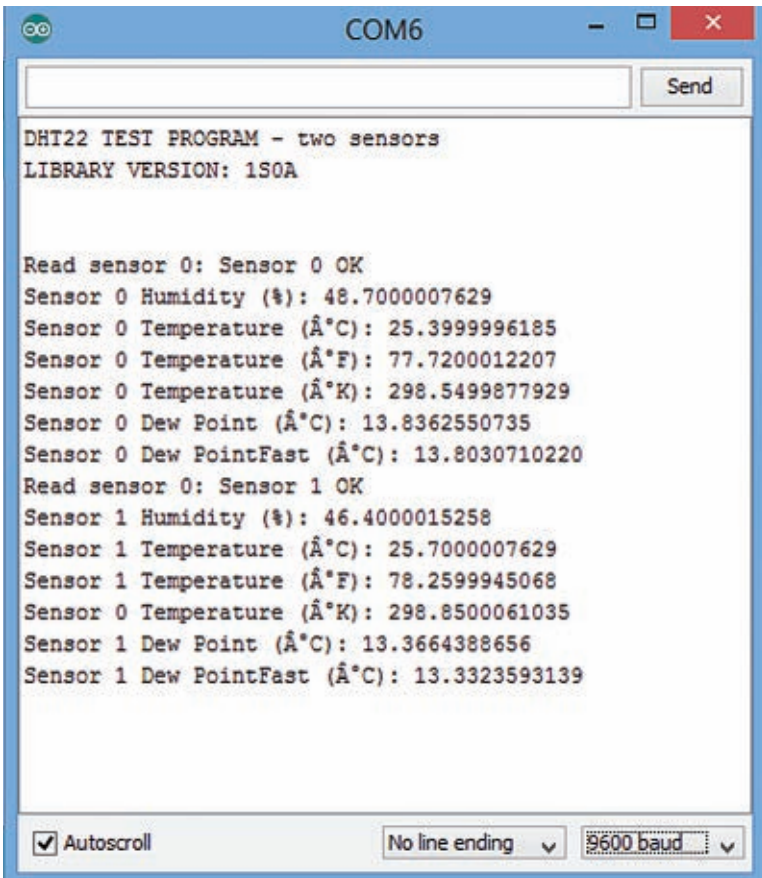

■ FIGURE 13: DHT22 example with two sensors.



■ FIGURE 14: Attic fan.

```
Serial.print("Dew Point (°C): ");
Serial.println(DHT22.dewPoint(), DEC);

Serial.print("Dew PointFast (°C): ");
Serial.println(DHT22.dewPointFast(), DEC);
```

We see the output on the Arduino serial monitor in **Figure 10**. Note that this runs the serial port at 9600 baud.

Two DHT22 Sensors

Adding a second sensor is shown in **Figures 11** and **12** in Fritzing breadboard and schematic views. We connect the second sensor to the Arduino pin 10 and make a couple of minor changes in the code. We are now ready to go.

The following source code shows how simple it is to add a sensor to a project when you use a library. In the first example, we created an instance of the *dht22* class using *dht22 DHT22*. For the example that uses two sensors, we simply add two instances of the class with:

```
dht22 DHT220;
dht22 DHT221;
```

Next, we copy and paste some code as shown in the listing. We'll have two sensors working in a matter of minutes:

```
#include <dht22.h>

dht22 DHT220;
dht22 DHT221;

void setup()
{
  DHT220.attach(10);
  DHT221.attach(11);

  Serial.begin(9600);
  Serial.println("DHT22 TEST PROGRAM - two
  sensors ");
  Serial.print("LIBRARY VERSION: ");
  Serial.println(DHT22LIB_VERSION);
}

void loop()
{
  Serial.println("\n");

  int chk0 = DHT220.read();

  Serial.print("Read sensor 0: ");
  switch (chk0)
  {
    case 0: Serial.println("Sensor 0 OK");
            break;
```



```

    case -1: Serial.println("Sensor 0 Checksum
error"); break;
    case -2: Serial.println("Sensor 0 Time out
error"); break;
    default: Serial.println("Sensor 0 Unknown
error"); break;
}

Serial.print("Sensor 0 Humidity (%): ");
Serial.println((float)DHT220.humidity, DEC);

Serial.print("Sensor 0 Temperature (°C): ");
Serial.println((float)DHT220.temperature, DEC);

Serial.print("Sensor 0 Temperature (°F): ");
Serial.println(DHT220.fahrenheit(), DEC);

Serial.print("Sensor 0 Temperature (°K): ");
Serial.println(DHT220.kelvin(), DEC);

Serial.print("Sensor 0 Dew Point (°C): ");
Serial.println(DHT220.dewPoint(), DEC);

Serial.print("Sensor 0 Dew PointFast (°C): ");
Serial.println(DHT220.dewPointFast(), DEC);
Serial.print("Read sensor 0: ");

int chk1 = DHT221.read();

switch (chk1)
{
    case 0: Serial.println("Sensor 1 OK"); break;
    case -1: Serial.println("Sensor 1 Checksum
error"); break;
    case -2: Serial.println("Sensor 1 Time out
error"); break;
    default: Serial.println("Sensor 1 Unknown
error"); break;
}

Serial.print("Sensor 1 Humidity (%): ");
Serial.println((float)DHT221.humidity, DEC);

Serial.print("Sensor 1 Temperature (°C): ");
Serial.println((float)DHT221.temperature, DEC);

Serial.print("Sensor 1 Temperature (°F): ");
Serial.println(DHT221.fahrenheit(), DEC);

Serial.print("Sensor 0 Temperature (°K): ");
Serial.println(DHT221.kelvin(), DEC);

Serial.print("Sensor 1 Dew Point (°C): ");
Serial.println(DHT221.dewPoint(), DEC);

Serial.print("Sensor 1 Dew PointFast (°C): ");
Serial.println(DHT221.dewPointFast(), DEC);

delay(2000);
}

```

This provides the data to the serial monitor shown in **Figure 13**.

Fresh Air Controller Design

In order to control the fresh air, we need to know the

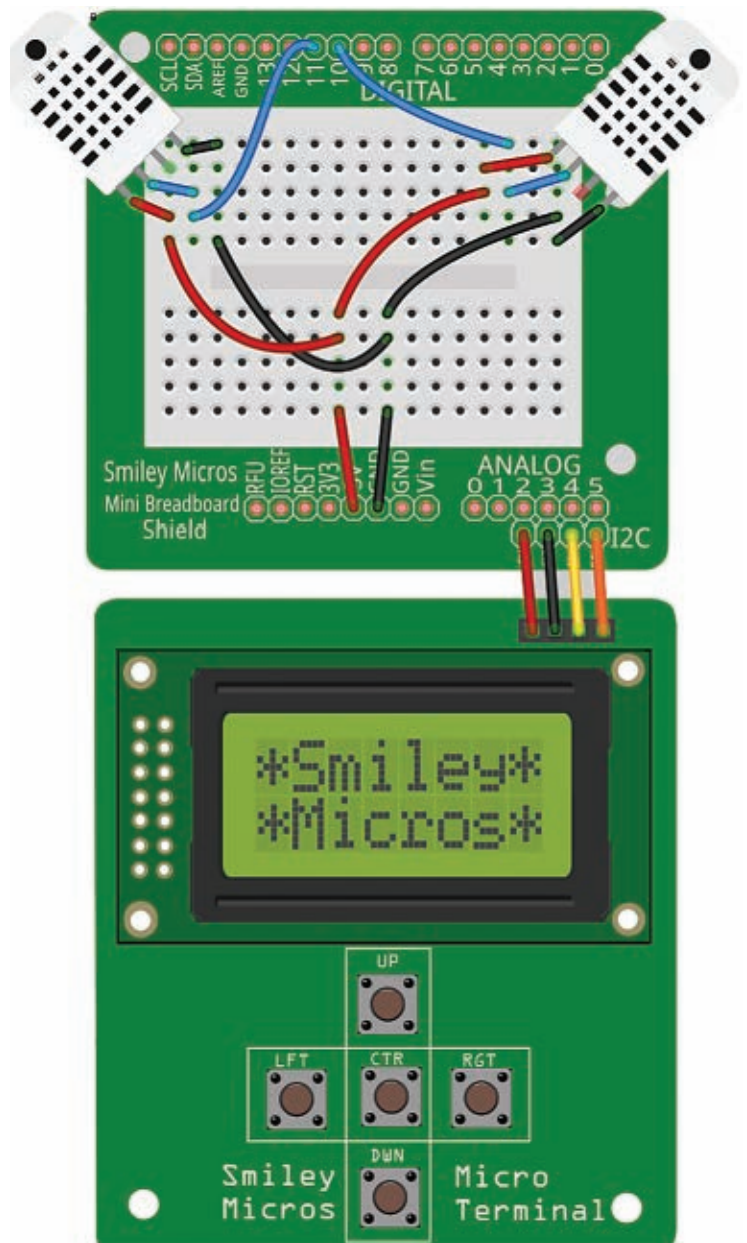

■ **FIGURE 15: Two DHT22s on handheld prototyper.**

temperature and humidity both inside and outside of the castle. We will look at an algorithm in a moment that lets us set trip points so our attic fan (**Figure 14**) will come on and draw fresh air through the vent box (refer back to **Figures 1** and **2**) to provide us with inexpensive cooling or heating as needed.

We hook up the I²C mini terminal part of the handheld prototyper as shown in **Figures 15** and **16**. This combines the Arduino proto shield and the I²C mini terminal into the handheld prototyper used in this system. The I²C mini terminal will let the user see the various

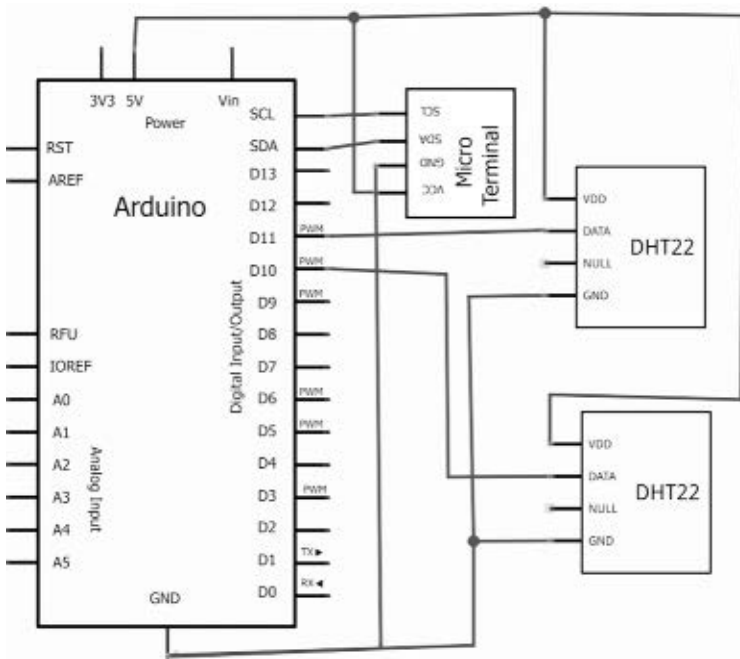

■ FIGURE 16: Fresh air controller schematic view.

temperature and humidity parameters on the LCD, and input temperature and humidity setpoints using the keys to select from menu items on the LCD.

The Fresh Air Controller Algorithm

The tasks for the fresh air controller seem fairly simple when you first think about them. If it is too warm indoors and cooler outdoors, you turn on the attic fan. If it is too cold indoors and warmer outdoors, you turn on the attic fan. If the attic fan is on and it starts to rain, you turn off the attic fan.

What you need is for the user to specify what is 'too warm' and 'too cold,' then let the computer logic do the rest. First, you will want to get the user to specify the following values:

```
setHumidity
setTempLow
setTempHigh
```

Then, you have the Arduino read the DHT22 for the following values:

```
humidityOutdoor
tempOutdoor
tempLow
```

This is the algorithm I came up with for deciding whether to turn the fan on or off, based on the above variables:

```
// Run the algorithm
if(humidityOutdoor >= setHumidity)
{
    fanState = 0;
}
else if( (tempOutdoor > setTempLow) &&
        (tempOutdoor < tempIndoor) &&
        (setTempLow != -1))
{
    fanState = 1;
}
else if( (tempOutdoor < setTempHigh) &&
        (tempOutdoor > tempIndoor) &&
        (setTempHigh != -1))
{
    fanState = 1;
}
else
{
    fanState = 0;
}

setFan(fanState);
```

Please note that in the above code the *else if* statement should be all on one line in the Arduino code. I split it up here for readability.

First, we check to see if the humidity outdoors is greater than the set humidity (meaning it is raining). If so, we turn the fan off.

Next, we check to see if the temperature outdoors is greater than our low temperature setting AND that the temperature outdoors is less than the indoor temperature, AND that the user has set the low temperature. If all that is true, we turn the fan on.

Then, we check to see if the temperature outdoors is less than our high temperature setting AND that the temperature outdoors is greater than the indoor temperature, AND that the user has set the high temperature. If all that is true, we turn the fan on.

Finally, if none of that is true, we turn the fan off.

Did I say 'fairly simple'? Well it is, but it took me a while to get my head around the logic. Maybe that says something about my head?

Next month, we will see how to complete the design for this handheld prototyper project using the I²C mini terminal to display the fresh air controller data on the LCD and get user feedback from the keys. **NV**

CLASSIFIEDS

KITS/PLANS

Electronic Kits

- Fun and Educational
- Discount White and Blue LEDs
- Quantity Discounts



www.bakatronics.com

D.I.Y. LASER TAG

www.LaserTagParts.com

PARTS | KITS | SCHEMATICS | FIRMWARE
FORUM | STORE | HOBBY & COMMERCIAL

LIGHTING



Automatic Stair Lighting

www.ReactiveLighting.com



- ◊ LED modules
- ◊ Solar controls
- ◊ Dusk to dawn
- ◊ Dimmers 12 V

eBay store name:

J2 LED LIGHTING LLC

<http://stores.ebay.com/j2ledlightingllc>

ROBOTICS

Ultrasonic Distance Sensing Made EZ

HRUSB-MaxSonar[®]-EZ™

- Multi-Sensor operation
- USB interface
- Easy integration
- 1 mm resolution
- Calibrated beam pattern
- Starting at \$49.95



HRXL-MaxSonar[®]-WR™

- High noise tolerance
- IP67 rated
- 1 mm resolution
- Multi-Sensor operation
- Calibrated beam pattern
- Starting at \$109.95



I2CXL-MaxSonar[®]-EZ™

- Great for UAV's and robotics
- Incredible noise immunity
- I2C interface
- 1cm resolution
- Automatic calibration
- Starting at \$39.95



www.maxbotix.com

QKITS.COM



\$69.95 USD

Robot Arm with 5 motors and 5 joints

1-888-GO 4 KITS

www.nutsvolts.com

COMPONENTS



RF PARTS™ CO.

Tubes, Transistors, Power Components
Email: rpf@rfparts.com • Web: www.rfparts.com

800-737-2787 Fax 888-744-1943

SURPLUS

SURPLUS ELECTRONIC PARTS & ACCESSORIES

Over 20,000 Items in Stock. Cables Connectors Displays Fans Hardware LEDs Motors Potentiometers Relays Semiconductors Service Manuals Speakers Switches Test Equipment Tools VCR Parts

Surplus Material Components
SMC ELECTRONICS
www.smcelectronics.com

No Minimum Order.
Credit Cards and PAYPAL Accepted.
Flat \$4.95 per order USA Shipping.

KIT BUILDING

KIT BUILDERS

Soldering and Assembly Service
Surface Mount or Thru-Hole
Components for one part, a selection of parts, the entire assembly or production quantities

408-842-8264 Work 831-578-5206 Cell
Wa6ouw@aol.com

www.kitbuildersqrpassemblyservice.com

HARDWARE WANTED

DEC EQUIPMENT WANTED!!!

Digital Equipment Corp. and compatibles.
Buy - Sell - Trade

CALL KEYWAYS 937-847-2300
or email buyer@keyways.com

Nuts & Volts Mobile App!



Check it out now at your favorite App Store!

ENERGY SOLUTIONS



Save Money On Your Electric Bill

www.sunny-solutions-shop.com

800-315-0309

Did You Know ...

Preferred Subscribers get access to all digital back issues of *Nuts & Volts* for free?

Call for details

1-877-525-2539

or go to

www.nutsvolts.com/faqs

Beginner's Guide Complete Combo!



Combo Price \$229.95

For complete details, visit our webstore @ www.nutsvolts.com.

www.servomagazine.com

>>> QUESTIONS

Lead-Free Soldering

I've finally used up my 2 lb roll of Kester lead-based solder and I'm ready to move to lead-free soldering. Is there anything I need to do to my existing soldering equipment to make the move? Anything else I should know?

#9131 **Frank Saris**
Carthage, MO

Arduino

I've hit the performance wall with my Arduino processor. I'm using the standard development environment and the latest version of the cards from SparkFun. Where do I go from here?

#9132 **Sandra Kinney**
Madison, WI

Need to See IR Light

I'm working with IR LEDs for a wireless stereo system in my living room. I'm having trouble visualizing the dead spots (shadows). Do you know any way to see the IR light distribution, short of me buying a pair of those night goggles from the military?

#9133 **Alonso Dorantes**
Johnstown, PA

>>> ANSWERS

[#7133 - July 2013] Battery Damage?

I have eight six volt lead acid batteries that provide "house" power

for my boat. The batteries have run dry on several occasions. It's hard to tell if the "run time" has been adversely affected since I don't usually allow them to fully discharge. Have they likely been damaged, and if so, will equalizing them restore lost capacity?

Yes, they have likely been damaged. I had to look up what "equalizing" a battery was since I wasn't sure.

Equalizing may help but I doubt that full capacity will be restored or if it is, that it will last very long.

I'm going to assume that these batteries are the deep discharge type, so you may be able to restore them at least partially.

I've noticed with my backup 12 volt deep discharge 70-80 AHr batteries for amateur radio and emergency use that once I let them get even partially dry, I can never get them back up to full capacity. On the other hand, I do not own a charger that can perform the equalization charge either.

So, I'd say since it likely won't hurt, give it a try.

My question is since you never run them down, you have no way to compare to see if this has improved anything. Also, since you never run them down, why worry about it? You never seem to need whatever the full capacity is anyway.

You may contact me if you like. I'm interested since I've done battery work both professionally at Marsh McBirney, Inc., and Gardner Labs, as well as in my amateur radio hobby.

Phil Karras, KE3FL
Mt Airy, MD

[#8131 - August 2013] Diode Selection on Multimeter

Why is there a diode selection on multimeters? What does the value mean?

#1 The diode setting measures the forward drop of a diode at a current of a few milliamperes. To ensure the diode is conducting, the potential across the meter probes is a few volts. On my aged RadioShack DVM, the open-circuit potential is 2.88 volts — sufficient to "turn on" most diodes, including red, yellow, and green LEDs, which glow dimly. Note that blue, ultraviolet, and white LEDs — as well as Darlington transistors and some high voltage diodes (that are, internally, series-connected diodes) — show as open circuits since they need a higher voltage to conduct.

The resistance setting is intended not to "turn on" a diode. So, on that setting, the voltage across the meter probes is only a few tenths of a volt. That allows accurate measurement of a resistor in parallel with a diode or across other semiconductor devices, except perhaps Schottky diodes which may have a forward-voltage drop of 0.2 volts.

See <http://en.wikipedia.org/wiki/Diode> for more information, but the list here is a rough guide to forward-voltage drop at a few mA:

Ge Schottky diode:	0.2V
Ge signal diode:	0.3V
Si rectifier:	0.6V
SiC Schottky diode:	0.6V
SiC junction diode:	0.6V

Send all questions and answers by email to forum@nutsvolts.com or via the online form at www.nutsvolts.com/tech-forum

All questions AND answers are submitted by *Nuts & Volts* readers and are intended to promote the exchange of ideas and provide assistance for solving technical problems. All

submissions are subject to editing and will be published on a space available basis if deemed suitable by the publisher. Answers are submitted by readers and **NO GUARANTEES**

WHATSOEVER are made by the publisher. The implementation of any answer printed in this column may require varying degrees of technical experience and should only be attempted by qualified individuals.

Always use common sense and good judgment!

Send all questions and answers by email to forum@nutsvolts.com
or via the online form at www.nutsvolts.com/tech-forum

Red GaAsP LED: 1.3V
Blue InGaN LED: 3.0V

Using the diode setting, you can usually identify the type of diode or junction transistor, as well as determine if it's open or shorted.

BTW, thanks for asking that question which inspired me to check the open-circuit voltage and current draw of my DVM diode and resistance settings. Now, my measurements should be a bit more meaningful.

Bart Bresnik
via email

#2 The "diode" range on digital multimeters is used to "measure" diodes (any type) to see if they are good or not. To use the range, connect the BLACK meter lead to the diode wire with the "stripe" on the diode body (cathode lead) and the RED meter lead to the other diode wire (anode lead). The following are "typical good" forward-bias readings for various diodes:

- Silicon diodes: 0.6-0.7
- Germanium diodes: 0.3-0.4
- Tunnel and Schottky diodes: 0.2-0.3
- Zener diodes: Similar to silicon diodes
- Selenium rectifier: 0.9-1.2 (approx)
- Power (i.e., 10A rating) and high voltage (i.e., kilovolt rating) diodes: 0.7-0.8
- LEDs: 1.6-1.8

Reversing the leads (reverse-biasing) will show "OL" — any "numerical" reading usually indicates the diode is shorted in reverse-bias. This range is also useful for checking the polarity of bipolar (PNP, NPN) transistors, if you don't know what kind you have:

- The emitter-base drop will read 0.5-0.6.
- The collector-base drop will read 0.7-0.8.
- The collector-emitter junction will

read OL (anything less indicates a blown transistor).

- Reverse-bias the emitter-base and collector-base junctions and you'll read OL (anything less indicates a blown transistor).

NOTE: The BLACK lead will tell you which lead(s) are the N lead(s) for determining PNP or NPN polarity (use the voltage drop difference to determine collector from emitter). It's also useful for determining the polarity of unmarked diodes: BLACK is cathode (stripe) and RED is ANODE. DO NOT use this range to measure FETs (field-effect transistors) as modern FETs are "static-sensitive" devices and will probably be destroyed from the action of taking the reading. SCRs, triacs (i.e., thyristors), and similar exotic junction-type devices cannot be accurately tested on this range. Finally, you can measure low value resistors (<2,000 ohms); the range usually has a buzzer associated with it for audible continuity readings (i.e., wire tracing, testing fuses).

Ken Simmons
Auburn, WA

[#8132 - August 2013] Capacitor Types

How do the different types of capacitors (ceramic, electrolytic, tantalum, etc.) differ and why would you use one type over another in a circuit?

#1 There are many types of capacitors in common use today, with many different properties. The key difference is the dielectric — or insulating material — between two metal plates. Here are some common types. All values shown are just rough approximations. Maximum capacity is expressed as nF (nanofarad), μ F (microfarad), and F (Farad); maximum voltage as V (volt) or kV (kilovolt); and maximum frequency as Hz (Hertz), kHz (kiloHertz), or MHz (megaHertz).

Air variable capacitor: Used in radio receivers and low power trans-

mitters. Value may be changed, but bulky for capacity. Max. \sim 1 nF, \sim 1,000V, \sim 100 MHz.

Vacuum variable capacitor: Used in high power transmitters. Value may be changed, but bulky for capacity. Max. \sim 1 nF, \sim 10,000 V, \sim 1,000 MHz.

Mica capacitor: Used in receivers and transmitters. Value is stable. Max. \sim 1 nF, \sim 1,000V, \sim 1,000 MHz.

Ceramic capacitor: Used in digital electronics, receivers, and transmitters. Value is less stable than mica, but more compact. Max. \sim 1 μ F, \sim 1,000V, \sim 1,000 MHz.

Al or Ta electrolytic capacitor: Used in audio frequency and power supplies. Al is cheap; Ta is more efficient. All require a DC offset and are destroyed by true AC or reverse voltage. Max. \sim 100,000 μ F, \sim 300V, \sim 30,000 Hz.

Ultracapacitor: Double-layer dielectric capacitors for power supplies and power backup. It offers very high capacity, and might eventually approach that of electrochemical cells, but has low voltage per capacitor, so are usually placed in series. Max. \sim 100 F, \sim 1V, \sim 100 Hz.

Other dielectrics are used, such as paper, plastics, glass, and water (yes, pure water has a high dielectric constant, low conductivity, and is environmentally friendly). Check out www.rle.mit.edu/cehv/documents/34-Phy.Tech..pdf.

Bart Bresnik
via email

#2 Ceramic caps are small, low loss, low leakage, and inexpensive, but the temperature coefficient varies from COG (very stable, 2% is available) to X7R (moderately stable, 10% is available) to Z5U (typically +20%, -80% over temperature). There is another type of ceramic called porcelain that is used in microwave applications; ordinary ceramics are too lossy at those frequencies.

Aluminum electrolytics are widely used because they are low cost and smaller than a film capacitor.

Electrolytic caps are leaky (measured in microamps), have internal resistance that may be significant in some applications, and vary with temperature ($\pm 20\%$ typically) and frequency (not useful at high frequency).

After six or more months on the shelf, aluminum electrolytic caps should be re-formed to regain their voltage rating.

Tantalum caps are also an electrolytic but smaller than aluminum, lower leakage, have a better temperature coefficient, and operate at higher temperature. Cost is more than aluminum but does not de-form (lose its voltage rating) with non-use.

There are other capacitor types to consider: mica, polypropylene, metalized polyester, polystyrene, and paper. Each has pluses and minuses to consider.

**Russell Kincaid
Milford, NH**

[#8133 - August 2013]

Antenna Length

Can someone explain how adding inductance or capacitance to an antenna changes the length?

An antenna becomes resonant when the energy that is racing down the wire hits the open end and is reflected back to the sending end; the transit time is equal to the time of one cycle of frequency. The open end has high voltage and low current (there can't be any current at the open end), and the sending end has high current and low voltage. Adding inductance at the sending end will lower the resonant frequency, thus making the wire appear longer. Adding capacitance to the open end will also reduce the resonant frequency. Since radiation occurs from the wire, adding these L and C elements will reduce the antenna efficiency because it is shorter than it would be if the L or C were not added.

**Russell Kincaid
Milford, NH**

[#8134 - August 2013]

Sine Wave

I would like to know how you can get a positive and a negative part of a sine wave from a circuit that runs on a nine volt battery.

You ask how to get a positive and a negative part of a sine wave from a circuit that runs on a nine volt battery. It is not clear how you are going to use that output, so I'll presume this is to satisfy your curiosity (or perhaps to help on your homework). The circuit suggested is not efficient, and would not make a good power supply.

First, a nine volt battery produces direct current, DC, with a steady amplitude of nine volts (gradually decreasing as it is drained). One simple circuit that produces a fair approximation of a sine wave from DC is a *phase shift*

oscillator, shown below on the left side (adapted from www.learnabout-electronics.org). The sine wave can be observed between the **Out** and the **0V** test points.

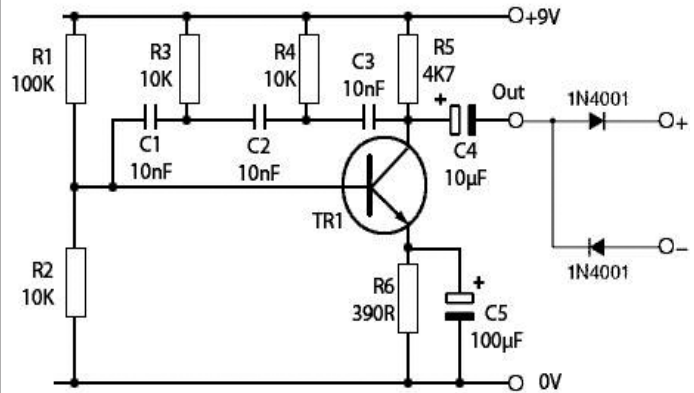

<http://www.learnabout-electronics.org/Oscillators/osc31.php>

Second, the sine wave must be separated into positive- and negative-going signals, which is done by the half-wave bridge rectifier. The two half-sine waves can be observed between the + or - test points and the 0V test point. The waveforms are shown below, (adapted from <http://macao-communications.museum>). The negative half-wave should look like the second graph flipped upside-down.

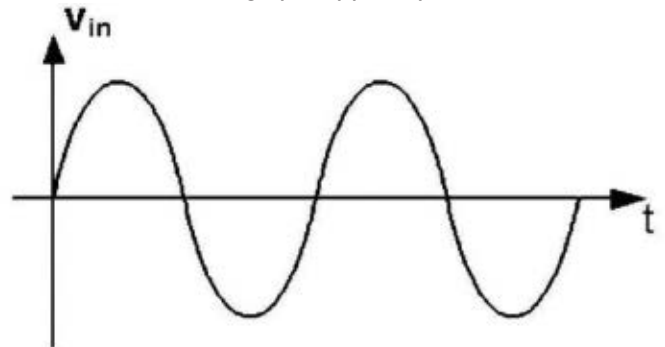

Figure 3a: AC Input Voltage Waveform

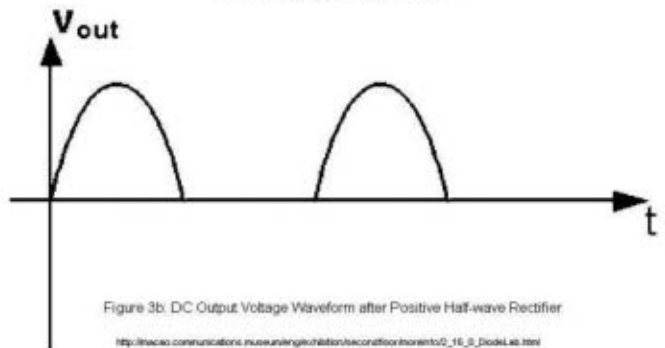

Figure 3b: DC Output Voltage Waveform after Positive Half-wave Rectifier
http://macao-communications.museum/voltage/halfwave/rectifier/outputto0_16_8_DiodeLab.html

If this did not answer your question, you might provide some more information as to how the signals would be used.

**Bart Bresnik
Mansfield, MA**

AMATEUR RADIO

AND TV

Ramsey Electronics82-83

BATTERIES/CHARGERS

Cunard Associates27

BUYING ELECTRONIC SURPLUS

Jaycar Electronics39

Weirdstuff Warehouse27

CAD/EDA TOOLS

Labcenter Electronics...Back Cover

CCD CAMERAS/VIDEO

Ramsey Electronics82-83

CIRCUIT BOARDS

AP Circuits47

Cunard Associates27

Dimension Engineering.....25

ExpressPCB33

Front Panel Express LLC47

Futurlec56

MCM Electronics21

PCB Pool56

Saelig Company Inc.20

COMPONENTS

Cana Kit Corp.68

Electronix Express49

Futurlec56

MCM Electronics21

SDP/SI27

COMPUTER

Hardware

Weirdstuff Warehouse27

Microcontrollers /

I/O Boards

Abacom Technologies20

Digital 6 Laboratories.....27

Images Co.56

microEngineering Labs48

MikroElektronika3

Pololu Robotics & Electronics.....5

Software

Labcenter Electronics...Back Cover

DESIGN/ENGINEERING/REPAIR SERVICES

Cana Kit Corp.68

ExpressPCB33

Front Panel Express LLC47

Images Co.56

PCB Pool56

DRIVE COMPONENT CATALOGS

SDP/SI27

EDUCATION

Command Productions25

NKC Electronics27

Poscope11

EMBEDDED TOOLS

NetBurner2

ENCLOSURES

Front Panel Express LLC47

KITS & PLANS

Cana Kit Corp.68

Jaycar Electronics39

NetBurner2

NKC Electronics27

QKITS27

Ramsey Electronics82-83

MISC./SURPLUS

All Electronics Corp.7

Front Panel Express LLC47

Weirdstuff Warehouse27

MOBILE RADIO MOUNTS

E Tip Inc.27

PROGRAMMERS

Futurlec56

microEngineering Labs48

MikroElektronika3

RF TRANSMITTERS/RECEIVERS

Abacom Technologies20

Digital 6 Laboratories.....27

E Tip Inc.27

ROBOTICS

Lemos International Co.63

Pololu Robotics & Electronics.....5

Robot Power27

SDP/SI27

SATELLITE

Lemos International Co.63

SECURITY

E Tip Inc.27

SOLDERING STATIONS AND IRONS

HAKKO47

TEST EQUIPMENT

Dimension Engineering.....25

Electronic Design Specialists49

Images Co.56

Jaycar Electronics39

MCM Electronics21

NKC Electronics27

Poscope11

Saelig Company Inc.20

TOOLS

HAKKO47

MikroElektronika3

NetBurner2

PanaVise56

Poscope11

WIRELESS PRODUCTS

Digital 6 Laboratories.....27

Abacom Technologies20

All Electronics Corp.7

AP Circuits47

Cana Kit Corp.68

Command Productions25

Cunard Associates27

Digital 6 Laboratories.....27

Dimension Engineering.....25

Electronic Design Specialists 49

Electronix Express49

E Tip Inc.27

ExpressPCB33

Front Panel Express LLC ...47

Futurlec56

HAKKO47

Images Co.56

Jaycar Electronics39

Labcenter

ElectronicsBack Cover

Lemos International Co.63

MCM Electronics21

microEngineering Labs.....48

MikroElektronika3

NetBurner2

NKC Electronics27

PanaVise56

PCB Pool56

Pololu Robotics & Electronics..5

Poscope11

QKITS.....27

Ramsey Electronics82-83

Robot Power27

Saelig Company Inc.20

SDP/SI27

Weirdstuff Warehouse27

Back To School Time!

Build It, Learn It, Achieve It, and ENJOY

Stereo Audio Platform Gain Controller

- ✓ Stereo audio processing while preserving audio dynamics!
- ✓ True stereo control keeps virtual sonic source location intact!
- ✓ Auto-bypass restores original levels when power is turned off!
- ✓ Unbalanced RCA and 3.5mm stereo input and output line level jacks!
- ✓ Built-in bar graph indication of signal level with display mute!



Your Full-Time Audio Engineer!

The SGC1 is one of our latest kits, and provides a great solution to the age-old problem: how can we easily correct inconsistent audio levels without negatively affecting the dynamics of the audio signal? The SGC1 circuit implements a principle known as the "Platform Gain Principle," which was originally developed by CBS Labs (what we now know as CBS in the TV and radio world) to allow transmitted audio levels to be automatically adjusted to keep them within a desired range.

Think of it like an audio engineer, constantly adjusting the output level in order to limit highs that would be too loud while boosting lower levels so that they can still be heard. You may think "oh, this is just another limiter/compressor!" Not so! Here's the real trick: keeping the full dynamic range ratio of the output signal the same as the original input - something the typical limiter/compressor can only dream of doing! The SGC1 can be placed in just about any standard analog stereo line level audio circuit (the red and white RCA connectors or the mini-phone connector) to keep the audio level within the desired range. It's also the perfect addition to any of our hobby kit transmitters, allowing you to match levels between different audio sources while keeping lows audible and preventing the highs from overdriving.

The SGC1 makes a great addition to any audio system where you need to keep levels from different sources under control, but still make sure they all sound great! In addition to its useful basic function and great audio performance, the SGC1 also boasts a front panel LED meter to give an indication of the relative level of the input signal, plus a level control (also on the front panel) that allows you to adjust the controller to the min/max center point of your desired level range. And yes, it is a **Stereo Gain Controller!** Meaning that the levels of both the left and right channels are monitored and adjusted equally, thereby maintaining the relative virtual position of things like instruments, singers and speakers! The entire unit is housed in a slim attractive black textured aluminum case that is sure to complement your studio or home theatre. If you're looking for perfect audio levels, hire a broadcast audio engineer, but if that doesn't fit your budget, the SGC1 is the next best thing! Includes 15VDC worldwide power adapter.

SGC1 Stereo Audio Platform Gain Controller Kit

\$179.95

Electrocardiogram ECG Heart Monitor

- ✓ Visible and audible display of your heart rhythm!
- ✓ Bright LED "Beat" indicator for easy viewing!
- ✓ Re-usable hospital grade sensors included!
- ✓ Monitor output for professional scope display
- ✓ Simple and safe 9V battery operation



Use the ECG1C to astound your physician with your knowledge of ECG/EKG systems. Enjoy learning about the inner workings of the heart while, at the same time, covering the stage-by-stage electronic circuit theory used in the kit to monitor it. The documentation with the ECG1C covers everything from the circuit description of the kit to the circuit description of the heart! Multiple "beat" indicators include a bright front panel LED that flashes with the actions of the heart along with an adjustable level audio speaker output that supports both mono and stereo hook-ups. In addition, a monitor output is provided to connect to any standard oscilloscope to view the traditional style ECG/EKG waveforms just like you see on ER... or in the ER! 10 hospital grade re-usable probe patches are included together with the matching custom case set shown. Safe 9V battery operation.

ECG1C Electrocardiogram Heart Monitor Kit With Case & Patches

\$44.95

ECG1WT Electrocardiogram Heart Monitor, Factory Assembled & Tested

\$89.95

ECGP10 Electrocardiogram Re-Usable Probe Patches, 10-Pack

\$4.95

Voice Activated Switch

Voice activated (VOX) provides a switched output when it hears a sound. Great for a hands free PTT switch or to turn on a recorder or light! Directly switches relays or low voltage loads up to 100mA. Runs on 6-12 VDC.



VS1 Voice Switch Kit

\$9.95

Passive Aircraft Monitor

The hit of the decade! Our patented receiver hears the entire aircraft band without any tuning! Passive design has no LO, therefore can be used on board aircraft! Perfect for airshows, hears the active traffic as it happens! Available kit or factory assembled.



ABM1 Passive Aircraft Receiver Kit

\$89.95

Laser Trip Sensor Alarm

True laser protects over 500 yards! At last within the reach of the hobbyist, this neat kit uses a standard laser pointer (included) to provide both audible and visual alert of a broken path. 5A relay makes it simple to interface! Breakaway board to separate sections.



LTS1 Laser Trip Sensor Alarm Kit

\$29.95

Logic Interface Module

Interface your digital output to the real world with an on-board SPDT relay rated at 240V at 10A! It takes a digital low (.5VDC or less) or a high (+1 to +12VDC) and provides your choice of an active low or high closure! It's that simple! Runs on 12VDC at 60mA.



RI1 Logic Interface Kit

\$17.95

4-Channel USB Relay Control

This professional quality USB relay controller allows computer controlled switching of external devices, plus full bi-directional communication with the external world using the USB port of your computer!

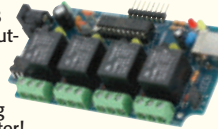

The controller features four onboard relay outputs with a current rating of 10A each. Also onboard is a 6-channel Input/Output interface, with each channel individually configurable as Digital Input, Digital Output, Analog Input (10-bit Resolution). In Digital Input/Output modes, each channel can support a TTL compatible or ST input or a 5V output signal. In Analog Input mode, each channel can convert a voltage of between 0 to 5V into a 10-bit digital representation.

UK1104 4-Ch USB Relay Interface Kit

\$59.95

Four-Mode Keyless Entry Test Set

Just like the days of "plugs, points, and condenser" are over, so are the days of having the hardware store grind out a spare key for your car!



Now when your keyless access system doesn't work, you need to accurately detect what part of the system is malfunctioning. This could be anything from a dead battery in the key fob, a "brain-dead" key fob, to malfunctioning sensors, antennas, or other system components in the vehicle. Until now there was no way to determine where the system was failing.

Testing your system is easy. To test the complete 125 kHz/315 MHz communications path just stand close to the vehicle with the WCT3 and your key fob in hand. Press the test button and the WCT3 will detect and display the presence of the vehicle's 125kHz/20kHz signal and, if they "handshake", will also detect and display the presence of your key fob's 315MHz return signal. You can independently test key fob only signals (panic, lock, trunk, etc.) by holding the key fob near the WCT3, pressing the test button, and pushing the function button on the key fob.

The same functionality testing can be done with IR key fobs. The modulated IR signal is detected and will illuminate the IR test LED on the test set.

If you know a few "secrets" you can also see if the tire pressure sensors/transmitters are generating signals or the built-in garage door opener in your rear view mirror is transmitting a signal! Runs on a standard 9V battery. Also available factory assembled & tested.

WCT3 Keyless Entry Test Set Kit

\$59.95

Air Blasting Ion Generator

Generates negative ions along with a hefty blast of fresh air, all without any noise! The steady state DC voltage generates 7.5kV DC negative at 400uA, and that's LOTS of ions! Includes 7 wind tubes for max air! Runs on 12-15VDC.

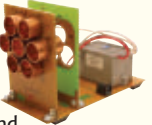

IG7 Ion Generator Kit

\$64.95

HV Plasma Generator

Generate 2" sparks to a handheld screwdriver! Light fluorescent tubes without wires! This plasma generator creates up to 25kV at 20kHz from a solid state circuit! Build plasma bulbs from regular bulbs and more! Runs on 16VAC or 5-24VDC.

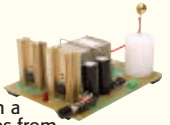

PG13 HV Plasma Generator Kit

\$64.95

Speedy Speed Radar Gun

Our famous Speedy radar gun teaches you doppler effect the fun way! Digital readout displays in MPH, KPH, or FPS. You supply two coffee cans! Runs on 12VDC or our AC121 supply.



SG7 Speed Radar Gun Kit

\$74.95

Broadband RF Preamp

Need to "perk-up" your counter or other equipment to read weak signals? This preamp has low noise and yet provides 25dB gain from 1MHz to well over 1GHz. Output can reach 100mW! Runs on 12 volts AC or DC or the included 110VAC PS. Assmb.



PR2 Broadband RF Preamp

\$69.95

Van de Graaff Generators

Create your own lightning with these time tested student favorites! Produces low current static currents that can be "shocking" but perfectly safe! Draw sparks to a screwdriver, grab hold and watch your hair stand straight up! Two models produce from 200kV to 400kV!



VG Van de Graaff Generators from \$139.95



Get the brand new 2013 Ramsey Hobby Catalog today! Filled with some of the neatest goodies around! Order yours today... Or download the PDF at www.ramseykits.com/catalog!

Follow Us and SAVE \$\$

Follow us on your favorite network site and look for a lot of super deals posted frequently... exclusively for our followers!

8-Channel Remote Ethernet Controller



Now you can easily control and monitor up to 8 separate circuits via the standard Ethernet network in your home or office. Connection wise it couldn't be simpler. The controller functions as an IP based web server, so it can be controlled by any internet browser that can reach your network! There are no drivers or proprietary software required, just access the controller like any web page from your PC, laptop, or even your smartphone! Security is assured allowing up to 4 separate user credentials. The controller can be set to a specific static IP within your network subnet or can be set to DHCP (auto negotiate). The controller can even be programmed to send you an email to notify and confirm power up and status changes!

To simplify the connection of your equipment to the controller, 8 separate and isolated relay outputs are provided! This gives you internet or network control of up to 8 separate functions. No need to worry about interfacing a logic high or logic low, or burning up the interface! The applications are endless! From something as simple as turning on and monitoring lights at your house with a normal latched closure to advanced control of your electronic gadgets, radio equipment, or even your garage door! Each relay contact is rated at 12A at 30VDC or 16A at 230VAC. Each of the 8 channels has built-in timer and scheduler programs for day, weekend, working days, every day, and every day except Sunday. Relay control functions are programmable for on, off, or pulse (1-99 seconds, 1-99 minutes, or 1-99 hours). In addition to control functions, the web interface also displays and confirms the status of each channel. Each channel can be custom labeled to your specific function name. The controller operates on 12VDC or 12VAC at 500mA or our new AC121 global 12VDC switching power supply below. Factory assembled, tested, and ready to go! Even includes a Cat-5 cable!

VM201 8-Channel Remote Ethernet Controller, Factory Assembled & Tested

\$169.95

Laser Beam Audio Communicator



Now you can talk to your friends over one of the most secure long-distance transmission types available, a laser beam! The transmitter uses a microphone or external audio to modulate a laser beam on and off at a rate of more than 16kHz so the audio fidelity is much better than that of a standard 3kHz telephone line!

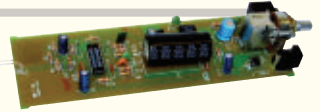

The receiver includes filtering to remove the 16kHz carrier and leave behind the high quality audio, and then boost its level for use with earphones. Transmitter audio AGC keeps your level perfect! Includes transmitter, receiver and laser pointer. Each runs on a 9V battery (not included).

LBC6K Laser Beam Audio Communicator Kit

\$59.95

5A PWM Motor Speed Controller

This handy controller uses a pulse width modulated output to control the speed of a motor without sacrificing torque! Handles a continuous current of 5A and includes LED to indicate speed as well as an oversized gold heatsink! Also available factory assembled.



CK1102 5A PWM Motor Controller Kit \$14.95

Digital LED Thermometer

This handy thermometer reads Celsius or Fahrenheit on an eye-catching .56" LED display! Based on the DS18B20 sensor and controlled by a PIC, it has a range of -67°F to 257°F (-55°C to 125°C) with a wired remote range of 325 feet!



CK127 Digital LED Thermometer Kit \$29.95

Tone Encoder/Decoder

Encode and decode with the same kit! This little mini-kit will simultaneously encode and/or decode any audio frequency between 40Hz and 5,000 Hz! Precision 20-turn trim pot adjustment! 5-12VDC.



TD1 Tone Encoder/Decoder Kit \$9.95

Tickle-Stick Shocker

The kit has a pulsing 80 volt tickle output and a mischievous blinking LED. And who can resist a blinking light and an unlabeled switch! Great fun for your desk, "Hey, I told you not to touch!" Runs on 3-6 VDC.

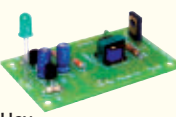

TS4 Tickle Stick Kit \$9.95

Laser Light Show

Just like the big concerts, you can impress your friends with your own laser light show! Audio input modulates the laser display to your favorite music! Adjustable pattern & speed. Runs on 6-12VDC.



LLS1 Laser Light Show Kit \$49.95

Optically Isolated Module

The hobbyist's headache solver! Converts any AC or DC signal to logic level. The beauty is that the input and output are totally isolated from each other! Output can drive up to 150mA at 40VDC.



OM2 Optically Isolated Module Kit \$16.95

Water Sensor Alarm

This little \$7 kit can really "bail you out"! Simply mount the alarm where you want to detect water level problems (sump pump)! When the water touches the contacts the alarm goes off! Sensor can even be remotely located. Runs on a standard 9V battery.



MK108 Water Sensor Alarm Kit \$6.95

12VDC Regulated Switching Supply

Go green with our new 12VDC 1A regulated supply. Worldwide input 100-240VAC with a Level-V efficiency! It gets even better, includes DUAL ferrite cores for RF and EMI suppression. All this at a 10 buck old wallwart price! What a deal!



AC121 12VDC 1A Regulated Supply \$9.95

Touch Switch

The ultimate touch switch! Touch once - it's on, touch again - it's off, or use the momentary outputs that stay on only as long as touched. Two switch circuits on each board. Drives loads up to 100mA. Runs on 6-12VDC.



TS1 Touch Switch Kit \$9.95

12VDC Worldwide Supply

It gets even better than our AC121 above! Now, take the regulated Level-V green supply, bump the current up to 1.25A, and include multiple blades for global country compatibility! Dual ferrite cores!



PS29 12VDC 1.25A Global Power Supply \$19.95

Tri-Field Meter Kit

"See" electrical, magnetic, and RF fields as a graphical LED display on the front panel! Use it to detect these fields in your house, find RF sources, you name it. Featured on CBS's Ghost Whisperer to detect the presence of ghosts! Req's 4 AAA batteries.



TFM3C Tri-Field Meter Kit \$74.95

Electronic Watch Dog

A barking dog on a PC board! And you don't have to feed it! Generates 2 different selectable barking dog sounds. Plus a built-in mic senses noise and can be set to bark when it hears it! Adjustable sensitivity! Unlike my Saint, eats 2-8VAC or 9-12VDC, it's not fussy!



K2655 Electronic Watch Dog Kit \$39.95

Electret Condenser Mic

This extremely sensitive 3/8" mic has a built-in FET preamplifier! It's a great replacement mic, or a perfect answer to add a mic to your project. Powered by 3-15VDC, and we even include coupling cap and a current limiting resistor! Extremely popular!



MC1 Mini Electret Condenser Mic Kit \$3.95

Sniff-It RF Detector Probe

Measure RF with your standard DMM or VOM! This extremely sensitive RF detector probe connects to any voltmeter and allows you to measure RF from 100kHz to over 1GHz! So sensitive it can be used as a RF field strength meter!



RF1 Sniff-It RF Detector Probe Kit \$27.95

Classic Nixie Tube Clocks **HOT SELLER!**



Our next generation of classic Nixie tube clocks perfectly mesh today's technology with the Nixie era technology of the 60's. Of course, features you'd expect with a typical clock are all supported with the Nixie clock... and a whole lot more!

The clocks are programmable for 12 or 24 hour mode, various AM/PM indications, programmable leading zero blanking, and include a programmable alarm with snooze as well as date display, 4 or 6 tube, kit or assembled!

We then jumped the technological time line of the 60's Nixie displays by adding the latest multi-colored LEDs to the base of the Nixie tubes to provide hundreds of illumination colors to highlight the glass tubes! The LED lighting can be programmed to any color and brightness combination of the colors red, green, or blue to suit your mood or environment.

Then we leaped over the technological time line by integrating an optional GPS time base reference for the ultimate in clock accuracy! The small optional GPS receiver module is factory assembled and tested, and plugs directly into the back of the clock to give your Nixie clock accuracy you could only dream of!

The clocks are available in our signature hand rubbed Teak & Maple, polished aluminum, or clear acrylic bases. You also have your choice of IN-14 or highly sought after IN-8-2 nixie tubes (for the 6-tube clock).

NIXIE Classic Nixie Tube Clock Kits From \$229.95

GET THE INUTS&VOLTS DISCOUNT!

Mention or enter the coupon code **NVRMZ12** and receive 10% off your order!

800-446-2295
www.ramseykits.com

RAMSEY ELECTRONICS®

590 Fishers Station Drive
Victor, NY 14564
(800) 446-2295
(585) 924-4560

Prices, availability, and specifications are subject to change. We are not responsible for typos, stupid, printer's bleed, end of summer blues, or excessive emails from Robin! Possession of this ad will not guarantee you acceptance into Harvard! Visit www.ramseykits.com for the latest pricing, specials, terms and conditions. Copyright 2013 Ramsey Electronics®...so there!

CAD CONNECTED



**Proteus Version 8
Launch Offer - SAVE 10%
Use NVL2013ATJ
When placing your order**

PROTEUS DESIGN SUITE VERSION 8

Featuring a brand new application framework, common parts database, live netlist and 3D visualisation, a built in debugging environment and a WYSIWYG Bill of Materials module, Proteus 8 is our most integrated and easy to use design system ever. Other features include:

- Hardware Accelerated Performance.
- Unique Thru-View™ Board Transparency.
- Over 35k Schematic & PCB library parts.
- Integrated Shape Based Auto-router.
- Flexible Design Rule Management.
- Polygonal and Split Power Plane Support.
- Board Autoplacement & Gateswap Optimiser.
- Direct CAD/CAM, ODB++, IDF & PDF Output.
- Integrated 3D Viewer with 3DS and DXF export.
- Mixed Mode SPICE Simulation Engine.
- Co-Simulation of PIC, AVR, 8051 and ARM MCUs.
- Direct Technical Support at no additional cost.

labcenter  www.labcenter.com
Electronics

**Visit our website or
phone 866.499.8184
for more details**

Labcenter Electronics North America 411 Queen St, Newmarket, Ont. Canada L3Y 2G9
Email: info@labcenter-electronics.com Tel: 905.898.0665 Fax 905.898.0683